

# Operating Manual

**CULO-M****Ex ia**

## ● Table of content

Page 2:	General informations - Safety
Page 3:	Safety (continued) - Technical Data
Page 4:	Mounting, commissioning
Page 5:	Mounting, commissioning (continued)
Page 6:	Adjustment, programming
Page 7:	Adjustment, programming (continued) - Transport, packaging and storage - Other
Page 8:	CE declaration of conformity

## ● General informations

### For information

- The current loop display, described in this operating manual, is carefully designed and manufactured using state-of-the-art technology. All components are subject to stringent quality and environmental criteria during production. Our management system is certified to ISO 9001.
- This operating manual includes important information on handling the current loop display. Basis for safe workings is the observance of all given safety and work instructions.
- Observe the relevant local accident prevention regulations and general safety regulations for the instrument's range of use.
- The operating instructions are part of the product and must be kept in the immediate vicinity of the instrument and readily accessible to skilled personnel at any time.
- Skilled personnel must have carefully read and understood the operating instructions, prior to beginning any work.
- The manufacturer's liability is void in the case of any damage caused by using the product contrary to its intended use, non-compliance with these operating instructions, assignment of insufficiently qualified skilled personnel or unauthorised modifications to the instrument.
- The general terms and conditions contained in the sales documentation shall apply.
- The instrument is subject to technical modifications.
- Additional information: Internet: [www.mueller-ie.com](http://www.mueller-ie.com)  
Datasheet: CULO-M  
Consultation: +49-05032-9672-0

## ● 2 Special Conditions



The display has to be built into a case (control panel or cabinet) with a degree of protection of at least IP20. The device has to be established and maintained in a way, that a dangerous electrostatic charge not has to be expected. As an example, this can be ensured by mounting the unit into a grounded, conductive frame.

The permitted ambient temperature range can be found in this manual or the EC type examination certificate.

## ● 3 Safety



Before installation, commissioning and operation, ensure that the appropriate current loop display has been selected in terms of measuring range, design and specific measuring conditions.

Non-observance can result in serious injury and/or damage to the equipment.

Further important safety instructions can be found in the individual chapters of these operating instructions.

### Intended Use of product

ATEX-Certification: Intrinsically safe current loop display intended for use in potentially explosive atmospheres. (The EC type examination certificate ZELM 05ATEX 0252 X for download at [www.mueller-ie.com](http://www.mueller-ie.com))

The current loop display has been designed and built solely for the intended use described here, and may only be used accordingly.

The technical specifications contained in these operating instructions must be observed. Improper handling or operation of the device outside of its technical specifications requires the instrument to be taken out of service immediately and inspected by an authorised service engineer.

The manufacturer shall not be liable for claims of any type based on operation contrary to the intended use.

### Personnel qualification



Risk of injury if qualification is insufficient!

Improper handling can result in considerable injury and damage to equipment.

- The activities described in these operating instructions may only be carried out by skilled personnel who have the qualifications described below.

- Keep unqualified personnel away from hazardous areas.

### Personnel

Skilled personnel are understood to be personnel who, based on their technical training, knowledge of measurement and control technology and on their experience and knowledge of country-specific regulations, current standards and directives, are capable of carrying out the work described and independently recognising potential hazards.

Special operating conditions require further appropriate knowledge, e.g. of explosive media.

### ● 3 Safety (continued)

#### Special risks



A non-observance of this content and instructions can lead to a loss of explosive protection.



The information of the EC type examination certificate and the corresponding national specific regulations for installation and use in hazardous areas (z. B. IEC 60079-14) have to be followed. A non-observance may cause serious injuries and/or damages.

#### Type CM1... (Ex-version)



**Observe absolutely: Repairs are forbidden. It is not allowed to use indicators with external damages. Observe the notes for mounting and operating, the regulations for the use of equipment in Ex areas, too.**

The current loop display has to be built in an control panel or cabinet with a grounded frame and a degree of protection of at least IP20.

It is not allowed to carry out any changes on the display.



Only related intrinsically safe equipment with a separate EC Type Examination Certificate, which does not exceed the electrical limiting values of the intrinsically safe circuit, can be used:

**Maximum terminal voltage:**  $U_0 = 30 \text{ VDC}$   
**Maximum current:**  $I_0 = 100 \text{ mA}$   
**Maximum power:**  $P_0 = 1 \text{ W}$

### ● 4 Technical Data

#### Input

Current loop: 4...20 mA  
Input resistance:  $R_i < 160 \text{ ohms}$  ( $U = < 3,2 \text{ V}$ )

#### Accuracy

Resolution: -999...9999 digit  
Measuring fault:  $\pm 0,2\%$  of measuring range,  $\pm 1$  digit  
Temperature drift: 100 ppm/K

#### Indication

Display: 7- segment, 14 mm, red, 4-digits  
Overflow/Underflow: to HI / to LO  
Time of indication: 0,1 s - 1 s - 10 s (adjustable)

#### Ambient conditions

Operating temperature: Standard:  $0...+80^\circ\text{C}$  / Ex-type:  $-20...+50^\circ\text{C}$   
Storing temperature:  $-20...+80^\circ\text{C}$

#### Programmable features

Range of indication / time of indication / decimal point / unit ( $^\circ\text{C}/^\circ\text{F}$ ) / stabilisation zero point / programming lock / calibration points / TAG-number

#### Certificate

EC type examination certificate: ZELM 05 ATEX 0252 X

#### Mechanics

Enclosure: Switchboard mounting: 96x48x28 mm  
Material: Polycarbonate  
Flammability: UL94 HB  
Mounting: 2 parts  
Sealing: Flat packing: EPDM, 65 Shore, black  
Mounting: Cutout: 92x45 mm  
Wall thickness: up to 3 mm  
Protection: Front: IP 67  
Connection: Connection: IP 20  
Plug-in terminal strip: 4-pole  
Cross-section: up to 1,5 mm<sup>2</sup>  
Weight: approx. 75 g

## 4 Mounting, commissioning

### Note

This operating manual is for use with:

Type CM0... (Standard type) and Type CM1... (Ex type, ZELM 05 ATEX 0252 X, II 2G Ex ia IIC T6)

### Example of Type label (Ex-version)

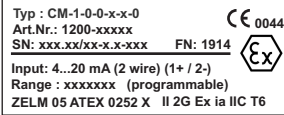

CM... : Product code  
 SN : Serial number  
 Art.Nr.: Order number  
 FN : Production number PCB (WWJJ)

### Dimensions (in mm), Cutout (in mm) and Mounting

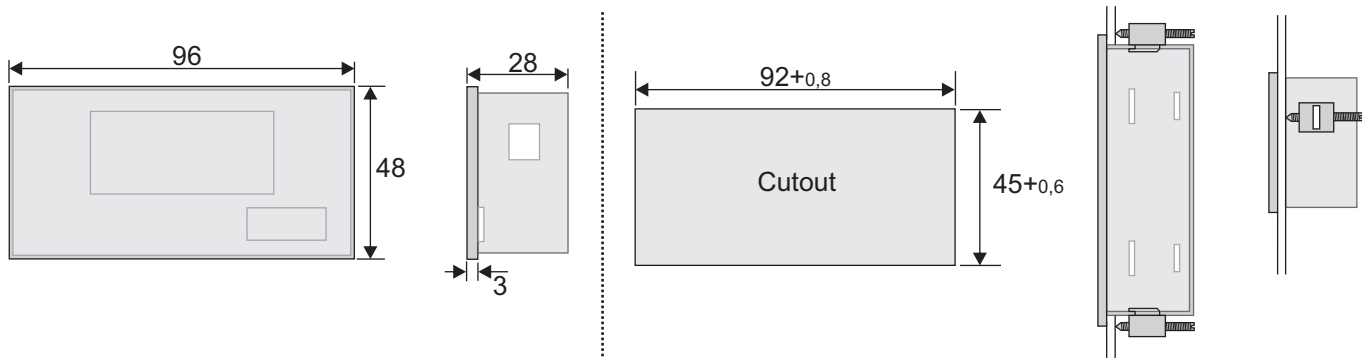

- Insert the display in cutout
- Put on the mounting clips
- Fasten locking screw with a screw driver

### Note for running a current loop display

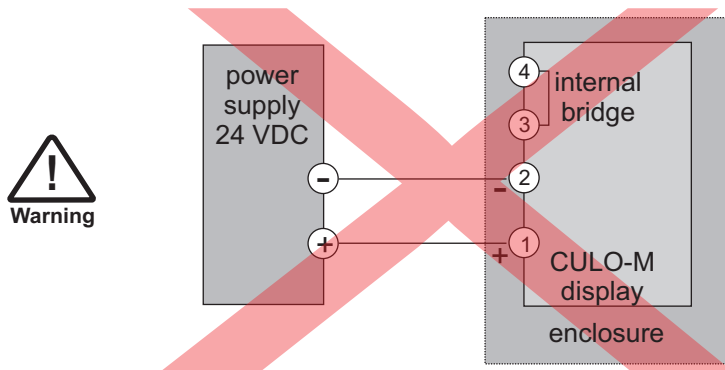

The display is operated in a current loop of 4...20 mA absolutely. A direct connection to a voltage supply (eg 24 VDC) will destroy the indicator and the guarantee does not cover this.

For an operational test the display has to be supplied out of a power source of 4...20 mA (eg mA source / calibration instrument).

In normal operation the display is connected in series with a transmitter (4...20 mA) or is connected to a 4...20 mA analogue output of a device.

### General connection (terminal strip)

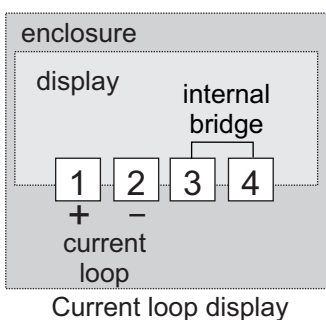

The 4-pole plug-in terminal strip to connect the current loop indicator is at the back of the display and is accessible after the enclosure is opened.

**Terminal 1:** positive pole of the current loop

**Terminal 2:** negative pole of the current loop

Terminal 3 and terminal 4 are bridged on the PCB and can be used for easy connection of a transmitter.

## ● 4 Mounting, commissioning (continued)

### Example for connection of type CM0... (no Ex-model)

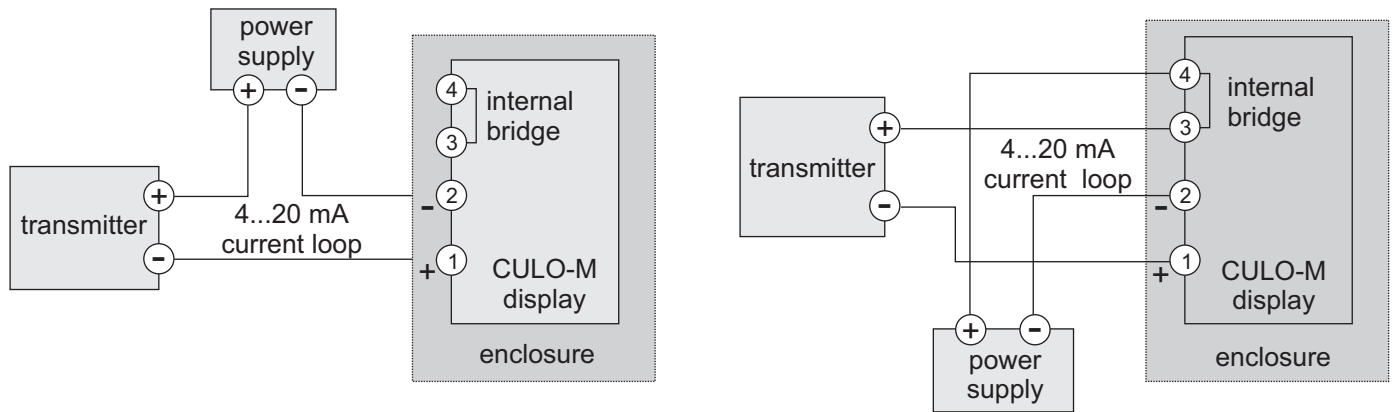

### Example for connection of type CM1... (Ex-model)

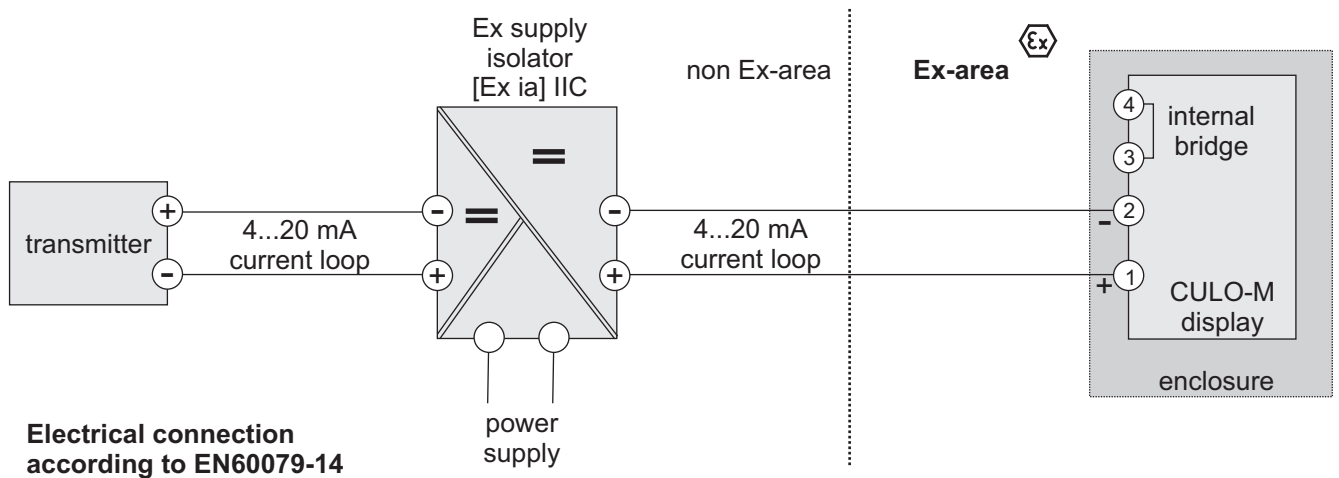

### Special regulations for mounting and operation of the current loop display Ex-version, type CM1...

The display has to be built into a case (control panel or cabinet) with a degree of protection of at least IP20.



Warning

The device has to be established and maintained in a way, that a dangerous electrostatical charge not has to be expected. As an example, this can be ensured by mounting the unit into a grounded, conductive frame.

The permitted ambient temperature range can be found in this manual or the EC type examination certificate.



The electrical connection must be carried out in an approved intrinsically safe circuit.

The following maximum values apply:

Voltage	$U_0 = 30 \text{ V}$
Current	$I_0 = 100 \text{ mA}$
Power	$P_0 = 1 \text{ W}$



Warning



The ambient temperature of the current loop display can change by means of additional components, eg due to heat output of a transmitter mounted into the enclosure or heat radiation of the measured medium when mounted into a connecting head of a temperature sensor. The operator of the current loop display has to guarantee, that in case of a failure event the allowed maximum ambient temperature of 50 °C is not exceeded.



Warning

Only the manufacturer is to be allowed to use the programming set because there exists no ATEX-certification for it!! The programming of the indicator has to be done with the three keys at the rear of the display only!!



## ● 6 Adjustment, programming

### View

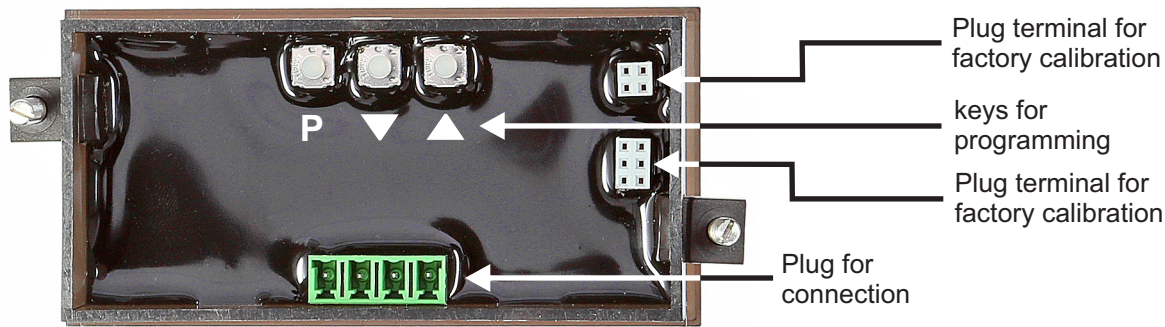

### Program table for programming the indicator

PN	Description	Range	Delivered state*
0	Calibration mode 0 = sensor calibration (with applied signal, for factory settings only) 1 = programming of indication (indicated value at 4/20 mA)	0/1	1
1	Final value (Programming the value at 20 mA, eg 600)	-999...9999	250
2	Initial value ( Programming the value at 4 mA, eg 100)	-999...9999	0
3	Selection of decimal point or unit (Programming a unit the indication shifts to the left)	0 / 0.0 / 0.00 0.000 / °F / °C	°C
4	Time of average / refresh of display (in 1/10 seconds)	5...100	10
5**	Stabilisation zero (the +/- range where 0000 is indicated)	0...100	2
50***	Definition PIN-code for programming interlock (value >0000)	0000...9999	0000
51***	Authentication with PIN-code (removal of programming interlock)	0000...9999	0000
100**	Number of calibration setpoints (calibration points for sensor calibration only, calibration points reduce the measuring rate)	0...30	0
101...130**	Calibration points (number according PN100)	-999...9999	0
200	TAG number	0000....9999	0

\*with factory configuration

\*\* when programming a value >1 a hysteresis of 0,1% is activated. This avoids a jumping indication.

\*\*\*optionally (if a PIN-code is not defined, PN50 and PN51 are hidden) The first time a PIN-code can be programmed only via interface during factory settings. When there is a definition for a PIN-code (indication of **Pin** during segment test), the programming interlock of PN51 has to be removed with the input of the defined PIN-code under PN50. When not removing PIN-code, all changings under all other PN cannot be stored. To activate the PIN-code of PN50 after a programming again, the programming mode has to be left with input of 0000 under PN50, optionally the current loop can be broken for a short time.

### Programming of indication

1. Connect the instrument according to the wiring diagram.
2. Switch power of the current loop on (current between 4...20 mA). This is followed by an initialisation and a segment test. Then **CULO** is indicated and afterwards the version of firmware (eg **F1.16**). Subsequent current loop display is switching into the operation mode.
3. Press the **P** key. Indication of program number **P 0**.
4. Change the program number by simultaneous pressing of **P** & **▲** keys or **P** & **▼** keys.
5. With the desired program number being chosen, go to the stored value by pressing the **P** key.
6. Short pressing of **P** results in a change of digit. The value of the chosen digit is changed with the **▼** or **▲** key.
7. Storing of the new settings is effected by pressing the **P** for approx. 2 sec. This procedure is acknowledged by transversal bars in the display.
8. If no other key is actuated, the unit switches to its operation mode after seven seconds.

#### Additional functions in standard mode for indication of min/max values

The **▲** key serves for indicating the value of the Max memory in the display for some seconds

The **▼** key serves for indicating the value of the Min memory in the display for some seconds

Simultaneous pressing of the **▲** and **▼** keys erases the values of the memory (minimum / maximum)

## ● 6 Adjustment, programming (continued)

### **Underflow / overflow**

Range: 4,00...20 mA / Indicated range: 3,90...20,10 mA / Usable range: 3,6...21,50 mA

Warning underflow: 3,60...<3,9 mA / Warning overflow: >20,10...21,50 mA

Indication underflow: <3,60 mA / Indication overflow: >21,50 mA

On warning the indicator flashes (normal indication is changing with bars).

Values below 3,60 mA: a bar is changing with indication **undr**.

Values above 21,50 mA: a bar is changing with indication **over**.

## ● 7 Transport, packaging and storage

### **Transport**

Check the current loop display for any damage that may have been caused during transportation.

Obvious damage must be reported immediately.

### **Packaging**

Do not remove packaging until just before mounting.

Keep the packaging as it will provide optimum protection during transport (e.g. change in installation site, sending for repair).

## ● 8 Other

### **Maintenance**



- The current loop display CULO-M requires no maintenance.
- Have repairs performed by the manufacturer only.
- Requirements of point 2 „Safety“ must be complied with.

### **Cleaning**



**Attention**

- Clean the instrument with a moist cloth.

### **Return**

When returning the instrument, use the original packaging or a suitable transport package. Be sure to include detailed information about the problem.

### **Disposal**

Incorrect disposal can put the environment at risk. Dispose of instrument components and packaging materials in an environmentally compatible way and in accordance with the country-specific waste disposal regulations.



● **CE conformity declaration**

We MÜLLER INDUSTRIE-ELEKTRONIK GMBH

( supplier's name )

Justus-von-Liebig-Straße 24  
31535 Neustadt  
GERMANY

( address )

declare that the product

CULO-M current loop display, types CM0xxxxx, CM1xxxxx

( name, type or model, batch or serial number, possibly sources and number of items )

is ( are ) in conformity with the following European CE-directives:

2004/108/EG

by the application with the following standard(s)

DIN EN 61000-6-2 and DIN EN 61000-6-4

and the type CM1xxxxx is in conformity with the following EC Type Examination Certificate:

ZELM 05 ATEX 0252 X

according the following European CE-directive:

94/9/EG:1994

by the application with the following standard(s)

EN 60079-0:2012 and EN 60079-11:2012

by the notified body number 0820

Prüf- und Zertifizierungsstelle  
ZELM Ex  
38124 Braunschweig  
GERMANY

Neustadt, 14.07.14

( Place and date of issue )

  
Müller Industrie-Elektronik GmbH  
Matthias Müller

( name and signature or equivalent marking of authorized person )