

TEPEX

make your work surroundings safer
progress always involves risks

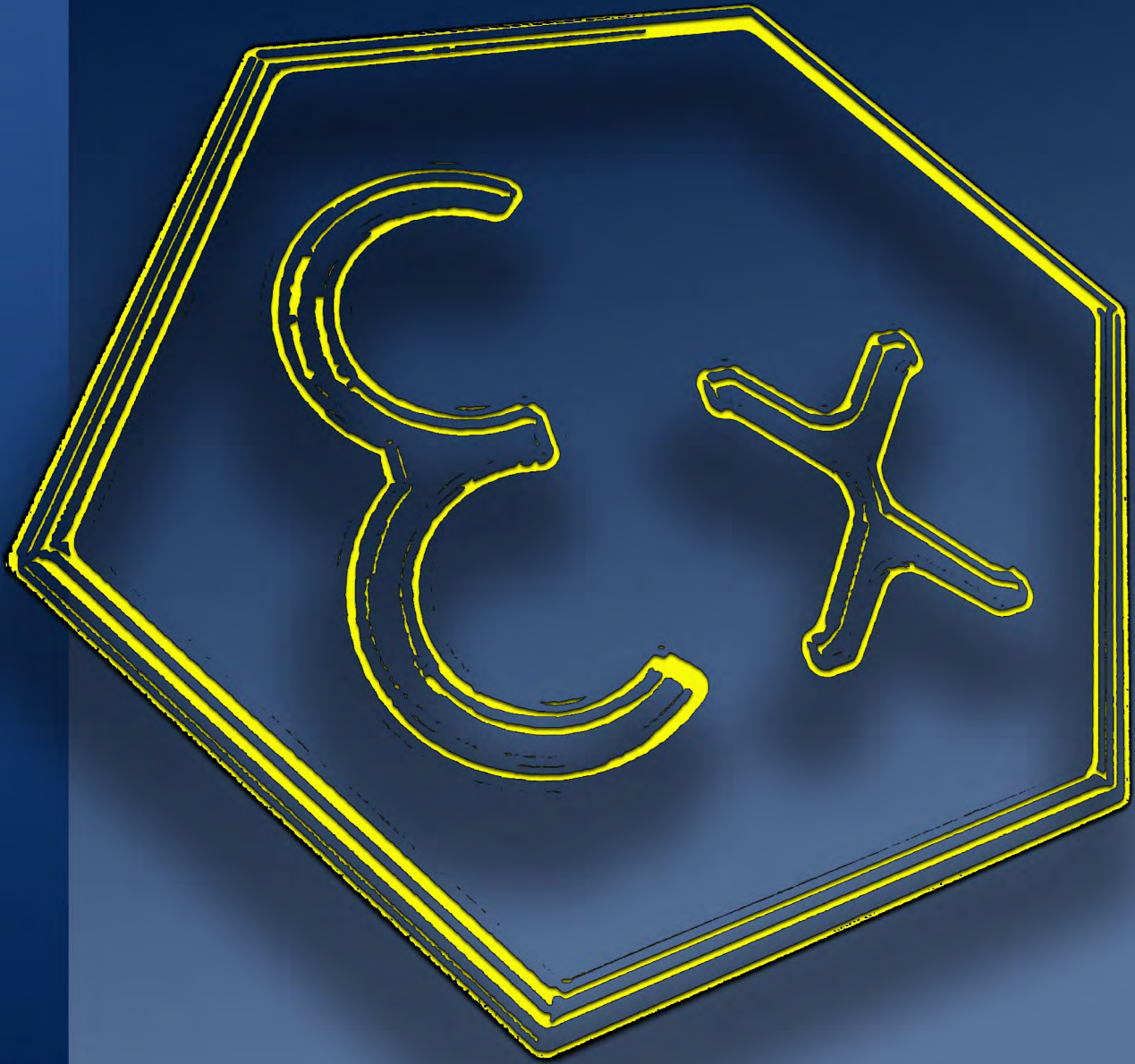

2020

2021

About us



TEP Ex is a regional leader in manufacturing of explosion-protected electrical equipment. Through continuous development of new products and markets, modernization of technology and investment in company employees and organization, we continue the tradition of more than 60 years of experience in the field.

Long-term company policy relies on our people and delivery of innovative products from our own development teams. Aiming for excellence is for us one of the most important corporate values. Our products are intended for use in potentially explosive atmospheres of gases, vapors and dust in industries such as refineries, offshore installations, petrochemical industry, chemical industry, pharmaceutical industry, food processing, shipbuilding and underground mining. The production program includes Ex light fittings, Ex installation material and accessories, Ex control units, Ex signal devices, Ex terminals, Ex distribution cabinets up to 630 V and 500 A.

In accordance with national regulative, all our products and systems for quality assurance are certified by an authorized certification notified body according to the **ATEX Directive 2014/34/EU**, according to the **EAC TR CU** (Technical Regulation Customs Union) the conformity of the production with the standards of the Customs Union formed by Belarus, Kazakhstan and Russian Federation. The production process is conducted according to high standards of **ISO 9001** (Quality Assurance System) and **ISO 14001** (Environmental Management System), ensuring high quality products with constant care for environment.

Based on our long history in producing supreme quality explosion protected electrical equipment, we are ready to deal with every demand or specific requirement of our customers.

If you require any additional information regarding our products or our company, we will be glad to answer your questions, with the professional approach from our Communication team.

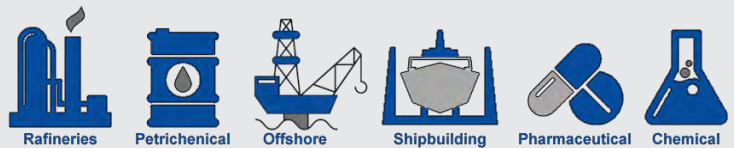

Europska unija
Zajedno do fondova EU

This project was co-financed by the European Union from the European Regional Development Fund

*The contents of this publication are the sole responsibility of TEP Ex d.o.o.
For more information on EU funds visit www.strukturnifondovi.hr*

Explosion protected products from the middle of the last century

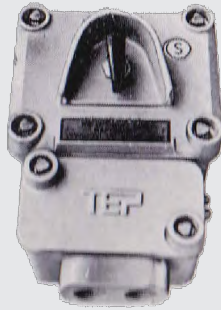

Examples of today's Ex products



1948.

TEPEX

2002.



TEPEX Ex

Production

The electrical equipment installed in areas with risk of explosion must be designed and tested in such way that it does not cause arcing or high temperatures which would provide a source of ignition for such a mix. For this reason, these materials must be provided only by companies able to attach the relevant product certificate of compliance with international standards.

This certificate, issued by competent and government authorized laboratories along with a test report, proves that the product is totally safe and suitable for installation in the concerned plant.

TEPEX Quality System conforms to the requirements:

ISO 9001:2015, ISO 14001:2015

All our Ex-protected products are certified in accordance with the European standard

ATEX Directive 2014/34/EU

also obtained the certifications for the Custom union, **EAC TP TC 012/2011**.

TEP Ex's employees use in the process of development and production modern production and development tools. Ongoing investment in project development ensures the availability of innovative high-performance products for installation in potentially explosive spaces.

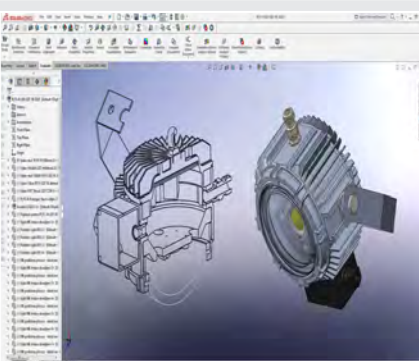

Ex LED light fittings

Following new trends in Ex lighting, and the advent of LED sources in explosive areas, TEPEX already in 2013. started production of Ex light fitting with LED light source (FLXE 118 LED). Currently, several types of Ex certified LED lamps (pendant max.100W and linear LED light fittings max. 70W).

It's time to change

LOW
MAINTENANCE

LONGER
SERVICE LIFE

OPERATING
COST SAVING

LUMINOUS
EFFICACY

In creating light-technical calculations it should be noted that the LED lighting (directional light) contribute to the reduction of light pollution of the atmosphere and losses on light scattering.

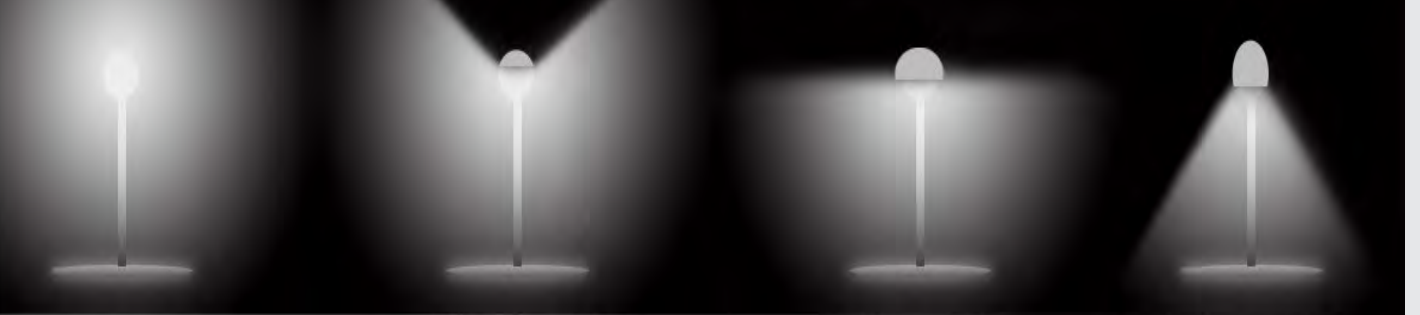

TEPEX LED light fittings products range

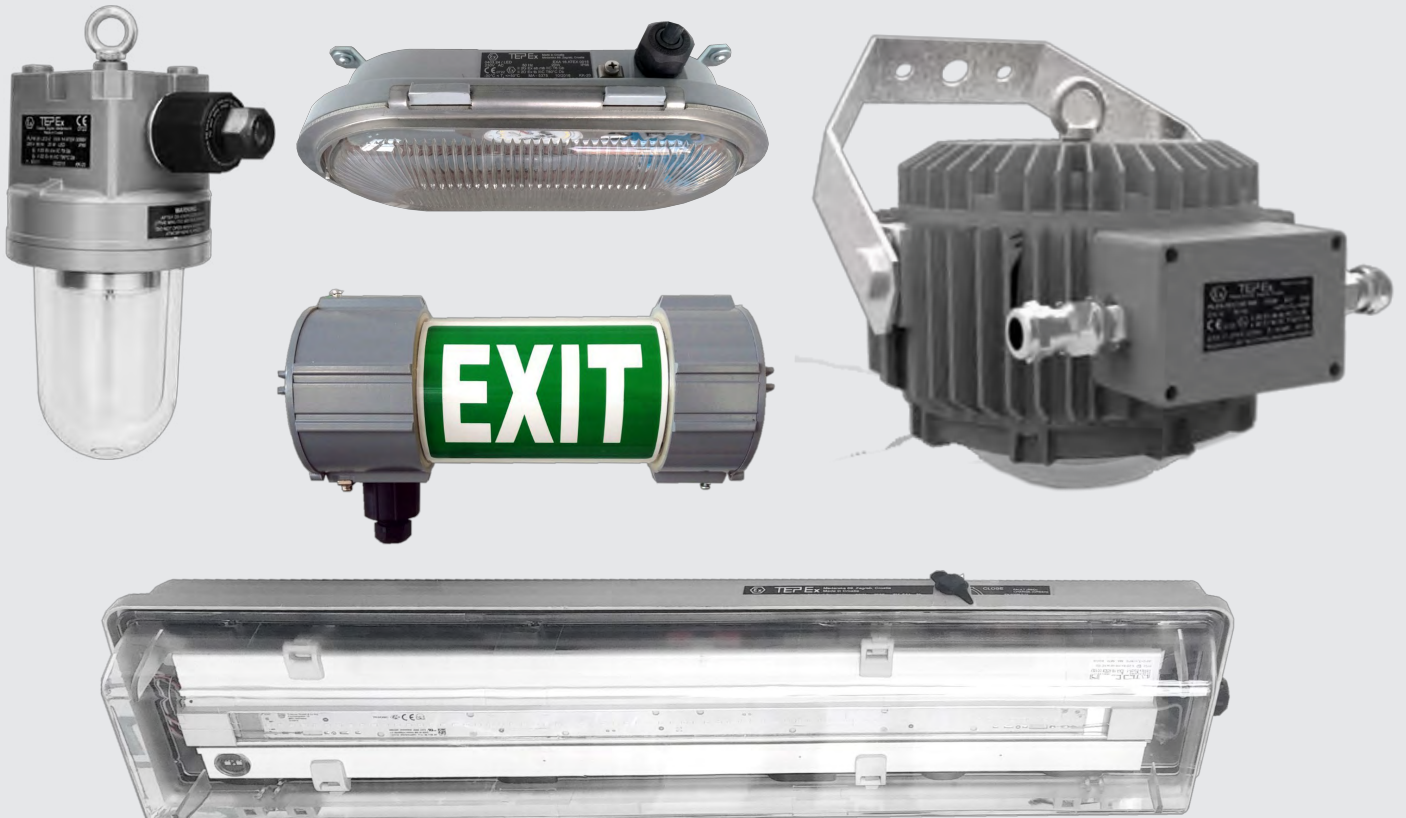

Ex BULKHEAD LIGHT FITTINGS, PENDANT LIGHT FITTINGS, FLOODLIGHTS		
Bulkhead light fitting 0403.24 LED		14
Pendant light fitting PLFM 20 LED		16
Pendant light fitting 0401.35 LED		18
Pendant light fitting PLFS 50 LED		20
Pendant/floodlight PLFS-N 100 LED		22
Bulkhead light fitting 0403.24		24
Pendant light fitting PLFM		26
Pendant light fitting PLFS-N		30
Pendant light fitting PLFL		32
Floodlight RLF		34
Ex LINEAR LIGHT FITTING		
Linear LED light fitting PSF LED		38
Linear LED light fitting FLX 310 LED		40
Fluorescent light fitting PSF		42
Fluorescent light fitting FLX		44
Fluorescent light fitting SIF		46
Ex EMERGENCY LIGHT FITTING		
Emergency light fitting FLXE LED		48
Emergency light fitting PSF LED-E		50
Emergency light fitting PSF E		52
Ex INSTALLATION EQUIPMENT		
Installation switch SKX SW		56
Junction boxes RK 01		58
Junction boxes JBX /E		60
Terminal boxes SKX/E		62
Terminal boxes SKX/E INOX (AISI 316L)		72
Busbar enclosure SKX		80
Ex CONTROL UNITS		
Control units SKX 12 SKX 15		86
Control units SKX 16 SKX 20		94
Ex GROUNDING CONTROL DEVICE		
Grounding device GGCD		106
Ex DISTRIBUTION CABINETS		
Distribution cabinets R3002....R3006		110
Ex PORTABLE LIGHTING, MOTION DETECTOR SENSOR		
Torchlights DF, headlamp DS , XT-70		116
Portable floodlight PLFS 50 LED PR		120
Motion detector sensor MDS		122
Ex SIGNALLING DEVICES, PLUGS AND SOCKETS, ACCESSORIES		
Signal horn mHPT,Signal bell dHW		124
Telephone dST1		128
Plugs and sockets		130
Multicore bushing RSM		136
Cable glands, adapters, reducers, locknuts		138

Explosive atmospheres occur when flammable gases, mist, vapors or dust are mixed with air. This creates a risk of explosion. The amount of a substance needed to create an explosive atmosphere depends on the substance in question. The area where this possibility exists is defined as a potentially explosive atmosphere.

These atmospheres can be found throughout industries, from chemical, pharmaceutical, food, to power, and wood processing. The areas may also be known as “*hazardous areas*” or “*hazardous locations*.”

GUIDE FOR EXPLOSION PROTECTION

Equipment and products operating in hazardous areas are required to meet stringent criteria. They must be “protected” to avoid the possibility of them becoming a source of ignition.

If the danger of explosion cannot be completely or only partly avoided by measures of preventing the formation of an hazardous explosive atmosphere, then measures must be taken that avoid the ignition of the explosive atmosphere.

Integrated explosion protection

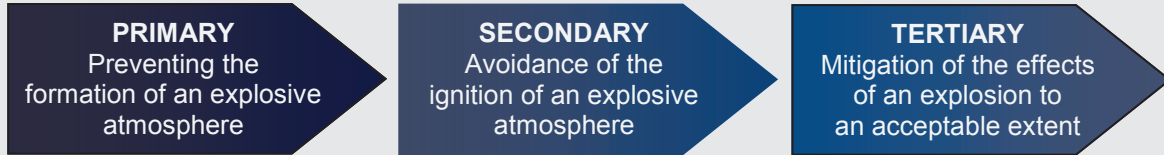

EXAMPLES OF ZONES CLASSIFICATION

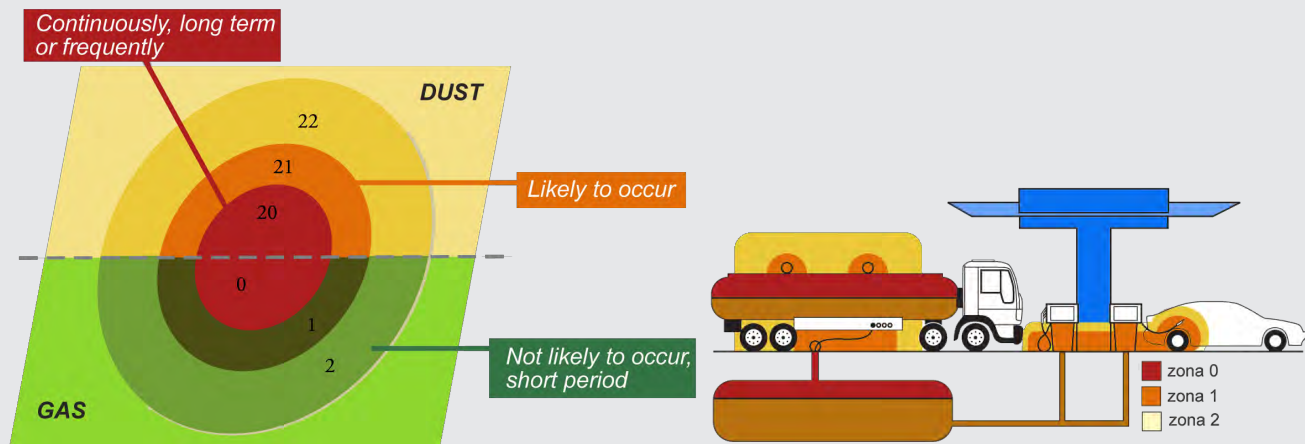

ZONE

Zone 0

An area in which an explosive atmosphere consisting of a mixture of air with flammable substances in the form of gas, vapour or mist is present continuously or for long periods or frequently.

Zone 20

An area in which an explosive atmosphere in the form of a cloud of combustible dust in air is present continuously or for long periods or frequently.

Zone 1

An area in which an explosive atmosphere consisting of a mixture of air with flammable substances in the form of gas, vapour or mist is likely to occur in normal operation occasionally.

Zone 21

An area in which an explosive atmosphere in the form of a cloud of combustible dust in air is likely to occur occasionally in normal operation.

Zone 2

An area in which an explosive atmosphere consisting of a mixture of air with flammable substances in the form of gas, vapour or mist is not likely to occur in normal operation, but if it does occur, will persist for a short period only.

Zone 22

An area in which an explosive atmosphere in the form of a cloud of combustible dust in air is not likely to occur in normal operation, but, if it does occur, will persist for a short period only.

Categories / Protection levels / Zones

AREAS	CATEGORIES	EPL	ZONES	EXPLOSIVE ATMOSPHERE
Mining - I	M1	Ma	/	>1,5% CH ₄
	M2	Mb		<1,5% CH ₄
Other than mines - II	1G, 1D	Ga, Da	0, 20	Continuously, long term or frequently
	2G, 2D	Gb, Db	1, 21	Likely to occur
	3G, 3D	Gc, Dc	2, 22	Not likely to occur, short period

















Maximum Surface Temperature	450°C						
	300°C						
	200°C						
	135°C						
	100°C						
	85°C						
Temp. Class	T1	T2	T3	T4	T5	T6	
Gas Groups	I	methane					
	IIA	ammonium, ethane, propane, benzene, methanol	ethyl n-butanol, n-butyl alcohol	benzine, kerosene, n-hexane, diesel fuel	etileter, acetilaldehyd, benzaldehyd, dibutyleter, diheksileter	-	-
	IIB	LPG mix	ethylene	hydrogen sulphide	etileter, dietileter	-	-
	IIC	hydrogen	acetylene	-	-	-	carbon disulphide

Dust Groups	
IIIA	Combustible flyings
IIIB	Non-conductive dust
IIIC	Conductive dust

Dust	Flash point [°C]		Minimum ignition energy (cloud) [mJ]	Lower Explosion Limit (cloud) [g/m ³]
	layer	cloud		
Cellulose	270	480	80	55
Sugar	400	370	30	45
Starch	380	400	25	25
Wheat	220	500	60	65
Sawdust	260	470	40	35
Aluminum powder	490-700	550-800	15-160	40-140
Zinc	540	690	960	460
Asphalt	550	510	40	35

EQUIPMENT PROTECTION LEVELS (EPL)		
Group I (Mining)	Ma	An apparatus for installation in a coal mine with possible presence of firedamp, with a level of protection "very high", which ensures a sufficient safety on the fact that it is not able to become a source of ignition during normal operation, during planned or malfunctions when subject to rare malfunctions even in the case where it is left electrically powered in the presence of a gas leak.
	Mb	An apparatus for installation in a coal mine with possible presence of firedamp, with a security level "high", which ensures a sufficient safety on the fact that it is not able to become a source of ignition during normal operation or during malfunctions envisaged in connection with interval of time that elapses between when there is a release of gas and when the equipment is, as a result of this, interrupted the power supply.
Group II (Gas)	Ga	An apparatus for potentially explosive atmospheres for the presence of gas, with a level of protection "very high", which is not a source of ignition during normal operation, during expected malfunctions or when subject to rare malfunctions.
	Gb	An apparatus for potentially explosive atmospheres for the presence of gas, with a security level "high", which is not a source of ignition during normal operation or during malfunctions provided.
	Gc	An apparatus for potentially explosive atmospheres for the presence of gas, with a level of protection "increased", which is not a source of ignition during normal operation and which presents some additional protective measures to ensure that it remains a source of ignition is not activated in the event of expected events regularly (for example, to the failure of a lamp).
Group III (Dust)	Da	An apparatus for potentially explosive atmospheres for the presence of combustible dust, which presents a protection level "very high", which does not constitute a source of ignition in normal operation, during expected malfunction, or when subject to rare malfunctions.
	Db	An apparatus for potentially explosive atmospheres for the presence of combustible dust, which presents a security level "high", which does not constitute a source of ignition in normal operation or when subject to possible failures.
	Dc	An apparatus for potentially explosive atmospheres for the presence of dust, with a level of protection "increased", which does not constitute a source of ignition during normal operation and which may have additional protections to ensure that it remains a source of ignition inactive in the case of expected events regularly (for example the failure of a lamp).

GUIDE FOR EXPLOSION PROTECTION

Types of protection for explosive atmosphere of flammable gases, vapors, mists or dusts EN/IEC 60079-0 - General Requirements					
Type of protection	Standard	Concept	Symbol	Category	EPL
Flameproof	EN/IEC 60079-1		d	2G M2	Gb Mb
Increased safety	EN/IEC 60079-7		e	2G M2	Gb Mb
Pressurized	EN/IEC 60079-2		px, py, pz	M2, 2G, 3G 2D, 3D	Mb, Gb, Gc Db, Dc
Intrinsic safety	EN/IEC 60079-11		ia, ib, ic	M1, M2, 1G, 2G, 3G 1D, 2D, 3D	Ma, Mb, Ga, Gb, Gc Da, Db, Dc
Type of protection "n"	EN/IEC 60079-15		nA nC nR	3G	Gc
Powder filling	EN/IEC 60079-5		q	M2, 2G	Mb, Gb
Oil - immersion	EN/IEC 60079-6		o	M2, 2G	Mb, Gb
Encapsulation	EN/IEC 60079-18		ma mb Mc	M1, M2, 1G, 2G, 3G 1D, 2D, 3D	Ma, Mb, Ga, Gb, Gc Da, Db, Dc
Protection by enclosures	EN/IEC 60079-31		tD ta, tb, tc	1D, 2D, 3D	Da, Db, Dc
Optical radiation	EN/IEC 60079-28		op_a op_b op_c	1G, 2G, 3G	Ga, Gb, Gc
Type of protection for non-electrical equipment EN 13463-1 / IEC 80079-36					
Flow restricting	EN 13463-2		fr	3G, 3D	/
Flameproof	EN 13463-3		d	M2, 2G	/
Constructional safety	EN 13463-5 prIEC 80079-37		c	M2, 1G, 2G, 3G 1D, 2D, 3D	Mb, Ga, Gb, Gc Da, Db, Dc
Control of ignition sources	EN 13463-6 prIEC 80079-37		b	M2, 1G, 2G, 3G 1D, 2D, 3D	Mb, Ga, Gb, Gc Da, Db, Dc
Liquid immersion	EN 13463-8 prIEC 80079-37		k	M1, M2, 1G, 2G, 3G 1D, 2D, 3D	Ma, Mb, Ga, Gb, Gc Da, Db, Dc
Pressurized	EN/IEC 60079-2		p	M2, 2G, 2D 3G, 3D	/

Typical Electrical Equipment Marking According to 2014/34/EU

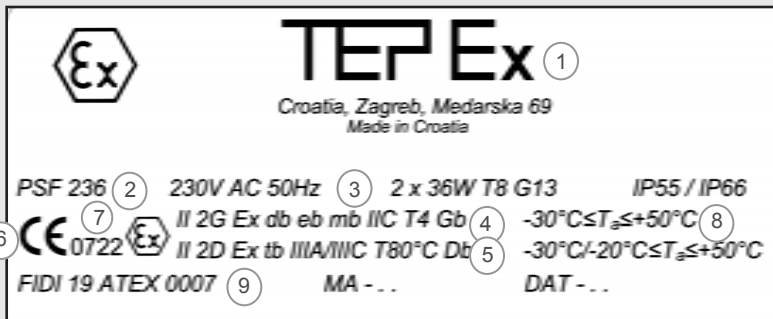
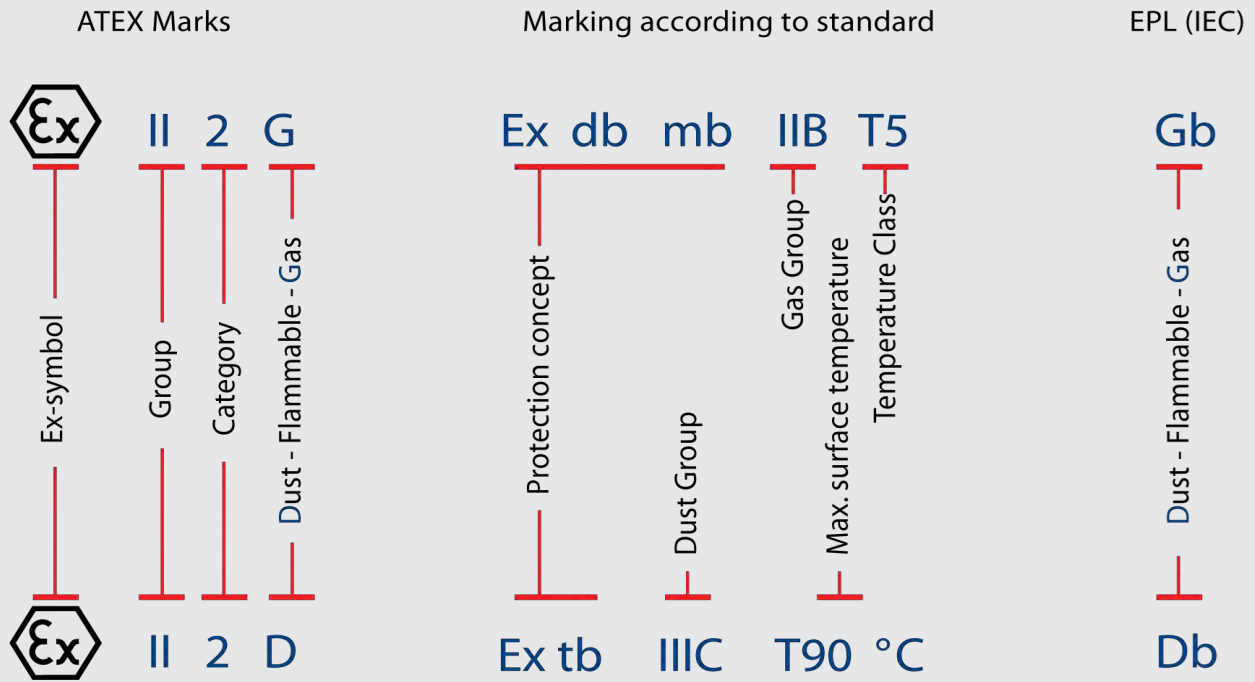

No	Description
1	Manufacturer's name and address
2	Product identification
3	Technical data
4	Indication of the Equipment Category and Hazardous Atmosphere
5	Marking of explosion protection
6	Conformity symbol, EU symbol CE
7	Notified body
8	Standard ambient temperature (-20 ÷ +40° C), unless otherwise stated on label
9	Certificate number and product number



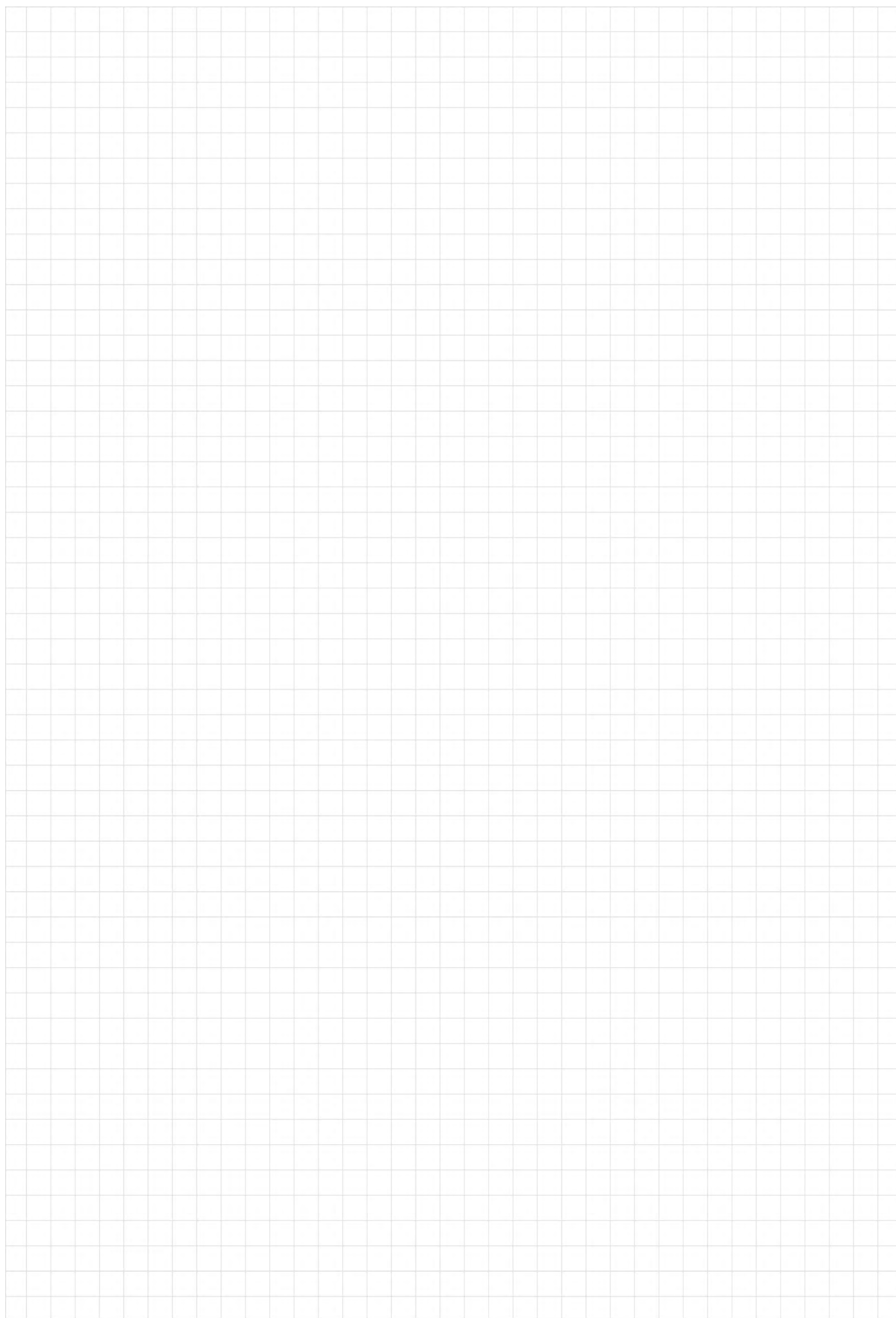



Light fittings

LED

IP 66

IK08

T_a
-30 +50Ex
ATEX

0403.24 LED

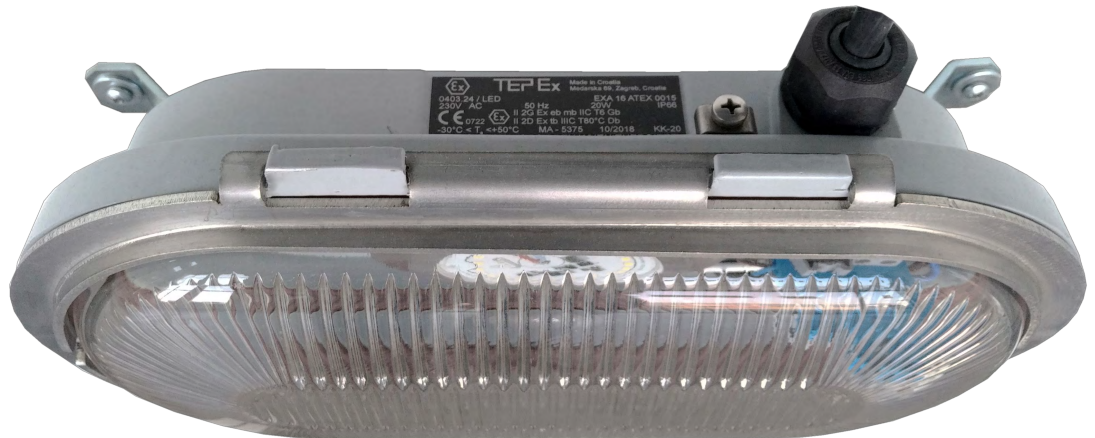

- Robust light alloy enclosure weighs only 4 kg
- Allowing the user to mount in areas where the available space is restricted
- Estimated service life 70 000 hours
- CCT 2700K

CONSTRUCTION

Housing: aluminium powder painted casting
 Diffuser: borosilicate glass, silicone gasket
 Protected grid: AISI 316
 Standard version without protected grid

TECHNICAL DATA

Certificate:	FIDI 19 ATEX 0059
Marking:	CE 0722
Apparatus category:	II 2G II 2D
Marking of explosion protection:	Ex eb mb op is IIC T6 Gb Ex tb op is IIIC T80°C Db
Ambient temperature:	-30°C ≤ T _a ≤ +50°C
Degree of protection:	IP 66 category 1
Resistance to shock:	IK 08
Protection class :	I (protective earthing)
Rated voltage:	230 VAC (48-230 VAC/DC ±15% Autonomous power supply / on request)
Frequency:	50Hz
Rated power:	17 W
Connecting terminals:	terminals L+N+PE , 2 x 4 mm ²
Cable entry:	2x M25 (1x M25 Exe cable gland, 1x Exe M25 plug)
Weight:	4 kg
Packing:	The packing contains: 1 pcs 360x240x205 mm

MOUNTING

Two brackets with two screws M6



Bulkhead LED light fitting

MODEL CODE

MODEL CODE / glass	LED POWER [W]	LUMINOUS FLUX [lm]	LIGHT OUTPUT RATIO η
0403.24 LED 20-1 / transparent	17W	1600	0,80
0403.24 LED 20-2 / green			0,60
0403.24 LED 20-3 / red			

POLAR CURVE

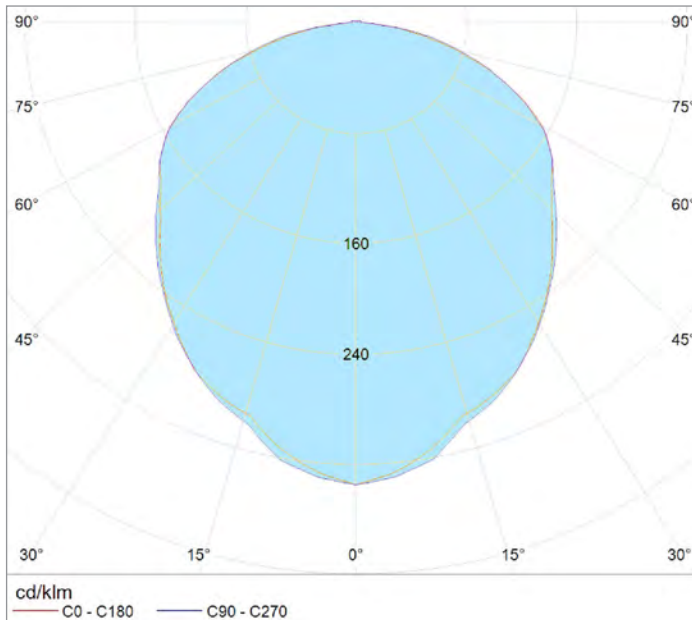

DIMENSION DRAWING (all dimensions in mm)

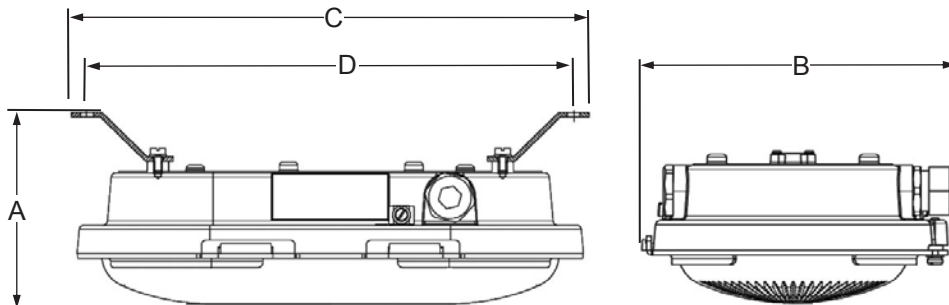

A	B	C	D
125	192	350	319

SPARE PARTS AND ACCESSORIES

SKETCH	DESCRIPTION	CODE	SKETCH	DESCRIPTION	CODE
	LEDEX 01 17W modul	0403.24 LED 10-110		Ex e cable gland M25	SPU 25
	Gasket 0403.24 LED	0403.24 LED 10-120		Ex e plug M25	SPC 25
	Glass cover	0403.24 LED 10-130		Wall bracket	0403.24 LED 10-160
	Protective grid	0403.24 LED 20-120		Pipe bracket R2"	0403.24 LED 10-170

LED

IP 66



IK08

T_a
C° -20 +40

PLFM LED



- Robust light alloy enclosure weighs only 3,5 kg
- Fast and easy installation
- PLFM 100/3 with E27 lampholder for LED bulb
- Estimated service life for LED module 20W ~ 70 000 h
- LED module with 100lm/W
- 4000K, CRI 80

CONSTRUCTION

Housing: aluminium powder painted casting

Diffuser: borosilicate glass

Accessories: protected galvanized steel gird (INOX on request), assembly kit for wall, pipe and ceiling mounting

Standard version without protected grid

TECHNICAL DATA

Certificate:	FIDI 19 ATEX 0047X
Marking:	CE 0722
Apparatus category:	II 2G II 2D
Marking of explosion protection:	Ex db eb op is IIC T6 Gb Ex tb op is IIIC T80°C Db
Ambient temperature:	-20°C ≤ T _a ≤ +40°C
Degree of protection:	IP 66 category 1
Resistance to shock:	IK 08
Protection class :	I (protective earthing)
Rated voltage:	230 V
Frequency:	50Hz (60Hz on request)
Rated power:	13 W, 20 W
Connecting terminals:	connection on tree-pole plug inside housing for connection L + N + PE; 2,5mm ²
Cable entry:	1x M20 (1x M20 Ex de adapter ADP 23/1 for cable 7-15mm) Or connection box for through wiring
Weight:	3,5 kg
Packing:	The packing contains: 1 pcs 440x260x170mm

MOUNTING

Pendant, on pipe, wall, ceiling

Pendant LED light fitting

MODEL CODE

MODEL CODE	LED POWER [W]	VOLTAGE [V]	LUMINOUS FLUX [lm]	LIGHT OUTPUT RATIO η
PLFM 100/3-	E27 / 12 W Osram E27 / 13 W Philips	230V	810 1055	0,80
PLFM 20 LED	LED module 20W		2000	

POLAR CURVE

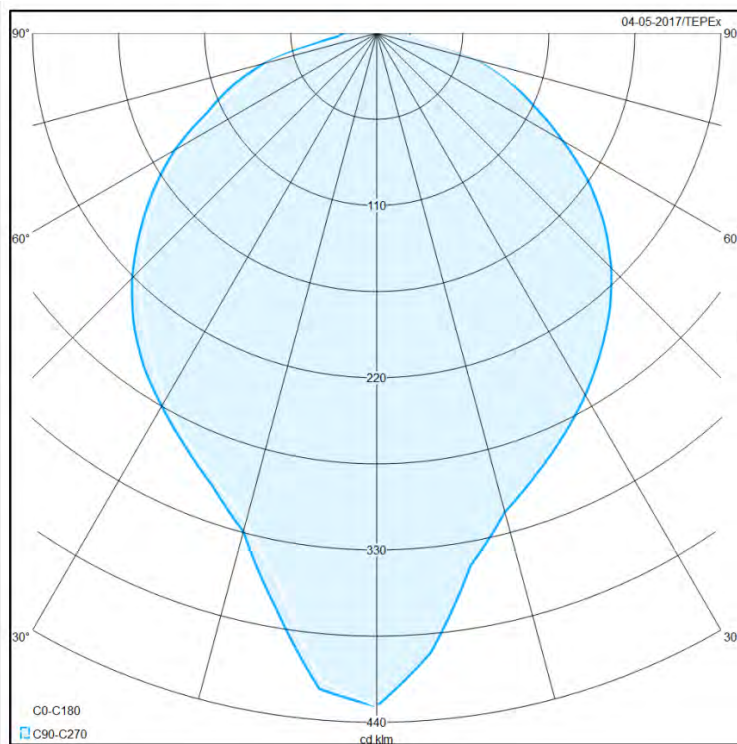

LED module 20W, 2000 lm

DIMENSION DRAWING (mm)

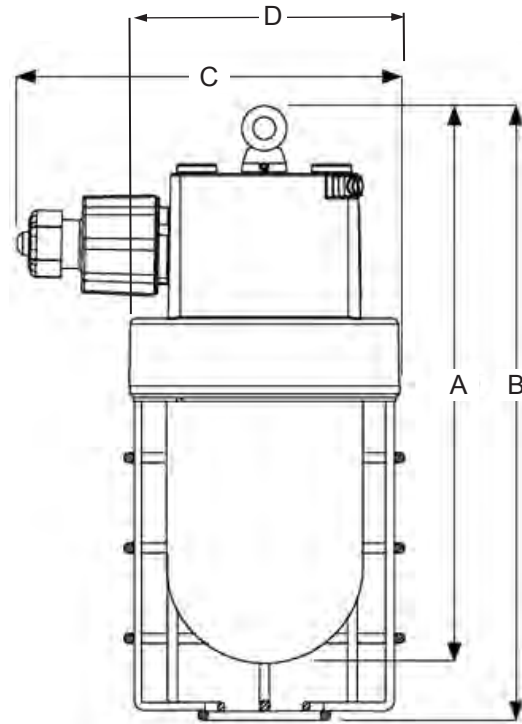

A	B	C	D
320	345	175	Ø140

SPARE PARTS AND ACCESSORIES

SKETCH	DESCRIPTION	CODE	SKETCH	DESCRIPTION	CODE
	Replacement glass PLFM	PLFM 10-120		Ex d metal plug M20	SPC 20
	Wire guard PLFM	PLFM 10-130		LED bulb E27	prema tablici izvedbi
	Gasket PLFM	PLFM 10-140		PLFM mounting bracket for pipe R2"	PLFM 20-120
	PLFM LED modul, set	PLFM 10-170		PLFM mounting bracket (ceiling)	PLFM 20-130
	Adapter ADP 23/1	PLFM 20-110		PLFM mounting bracket (wall)	PLFM 20-140

All technical data is relevant at the time of print.



IP 66



- Robust light alloy enclosure weighs only 6,5 kg
- Estimated service life 70 000 hours
- LED module with 100lm/W
- 4000K, CRI 80



CONSTRUCTION

Housing: aluminium powder painted casting
 Diffuser: borosilicate glass,
 Accessories: assembly kit for wall, pipe and ceiling mounting

TECHNICAL DATA

Certificate:	FIDI 19 ATEX 0046
Marking:	CE 0722
Apparatus category:	II 2GD
Marking of explosion protection:	Ex eb mb op is IIC T4 Gb Ex tb op is IIIC T80°C Db
Ambient temperature:	$-40^{\circ}\text{C} \leq T_a \leq +40^{\circ}\text{C}$
Degree of protection:	IP 66 category 1
Resistance to shock:	IK 08
Protection class :	I (protective earthing)
Rated voltage:	230 V AC
Frequency:	50Hz (60Hz on request)
Rated power:	30 W
Connecting terminals:	terminals L1 + N for $2 \times 4 \text{ mm}^2$ terminals PE for $2 \times 4 \text{ mm}^2$
Cable entry:	2x M20 (1x M20 Ex e cable gland for cable 7-15mm, 1x Exe M20plug) or ADP 13/1 or M20 metal cable gland
Weight:	6,5 kg

MOUNTING

Pendant, on pipe, wall, ceiling

Pendant LED light fitting

MODEL CODE

MODEL CODE	LED POWER [W]	VOLTAGE [V]	LUMINOUS FLUX [lm]	LIGHT OUTPUT RATIO η
0401.35 LED 30	30 W	230V	2850	0,84

POLAR CURVE

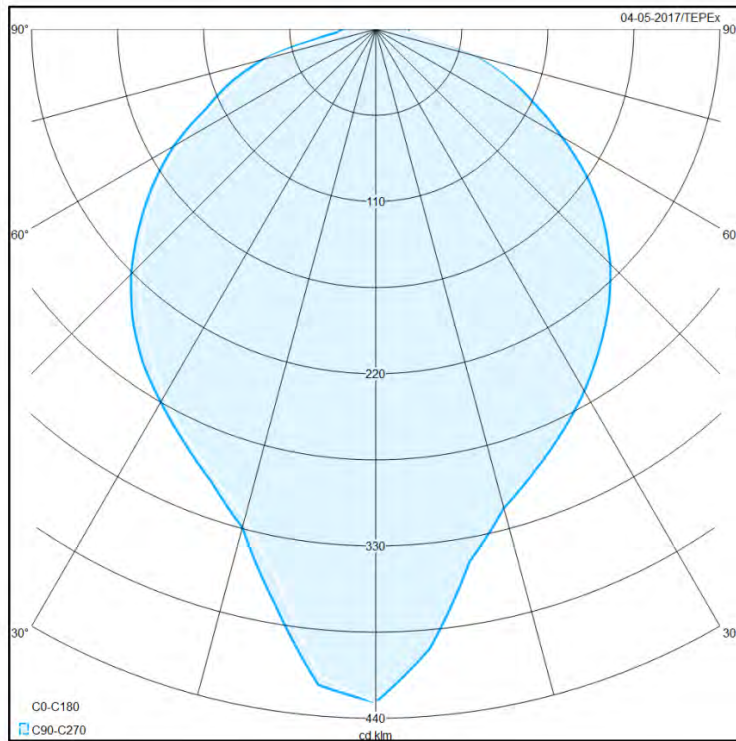

LED module 30W, 2850 lm

DIMENSION DRAWING (mm)

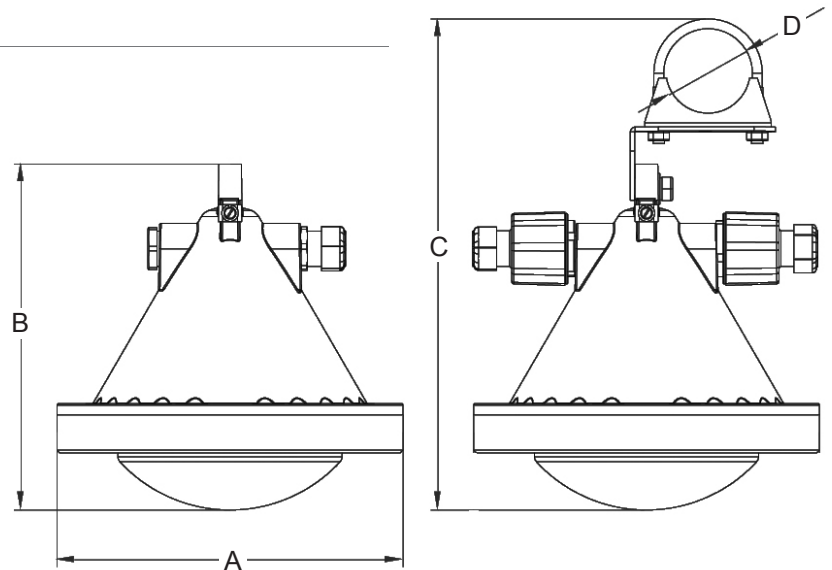

A	B	C	D
246	245	350	Ø65

SPARE PARTS AND ACCESSORIES

SKETCH	DESCRIPTION	CODE	SKETCH	DESCRIPTION	CODE
	Glass frame 0401.35 LED	0401.35 LED 10-130		Ex e cable gland M25	SPU 25
	Pipe mounting set 0401.35 LED	0401.35 LED 10-110		Terminal set	0401.35 LED 10-120

All technical data is relevant at the time of print.

LED

IP 66

IK08

T_a
-40 +50Ex
ATEX

EAC

PLFS 50 LED



CONSTRUCTION

Housing: aluminium powder painted casting

Diffuser: borosilicate glass,

Accessories: protected galvanized steel gird, assembly kit for wall, pipe and ceiling mounting

Gasket: silicon

TECHNICAL DATA

Certificate:	FIDI 19 ATEX 0030 , FIDI 19 ATEX 0070X EAC RU C-HR.AB24.B.03244
Marking:	CE 0722
Apparatus category:	II 2G II 2D
Marking of explosion protection:	Ex db eb op is IIC T6/T5 Gb Ex tb op is IIIC T80°C/T85°C Db
Ambient temperature ATEX: EAC:	See "model code" table -50°C ≤ T _a ≤ +50°C
Degree of protection:	IP 66 category 1
Resistance to shock:	IK 08
Protection class :	I (protective earthing)
Rated voltage:	90 - 305 V AC 127 - 431 V DC
Frequency:	50Hz / 60Hz
Rated power:	35W, 50W, 60W
Connecting terminals:	L1, L2, L3, N; max. 2 x 2,5 mm ²
Cable entry:	2x M25 (1x M25 Ex e cable gland for cable 7-15mm, 1x Exe M25 plug)
Weight:	7,5 kg
Packing:	The packing contains: 2 pcs 560 x 270 x 270 mm

MOUNTING

Pendant, on pipe, wall, ceiling,
recessed
(clean room LED light fitting)

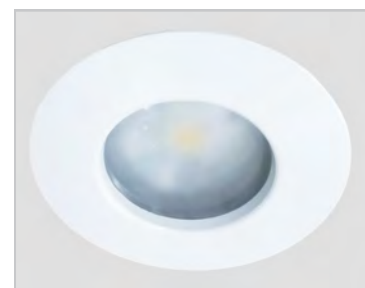
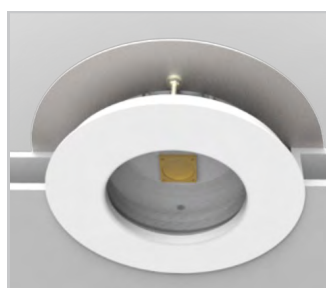

- Highest efficiency with luminous efficacy up to 170lm/W
- High color rendering index CRI 80
- Estimated service life 70 000 hours
- With OVP, OCP, OTP protection
- Autonomous reactivation after recovery
- CCT4000K / other CCT on request
- Frosted front glass on request

new
LED
more lm/W

Pendant LED light fitting

MODEL CODE

MODEL CODE	LED POWER [W]	VOLTAGE [V]	LUMINOUS FLUX [lm]	LIGHT OUTPUT RATIO η	AMBIENT TEMP.
PLFS 50 LED-1	35 W	90-305 V AC 127-431 V DC	5950	0,80	-40°C ÷ +60°C
PLFS 50 LED-2	50 W		8500		-40°C ÷ +55°C
PLFS 50 LED-3	60 W		10 200		-40°C ÷ +50°C

POLAR CURVE

DIMENSION DRAWING (mm)

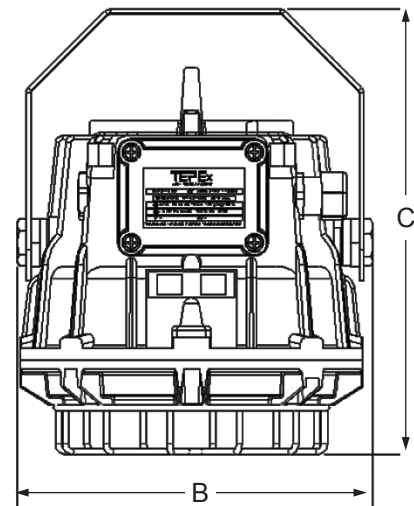
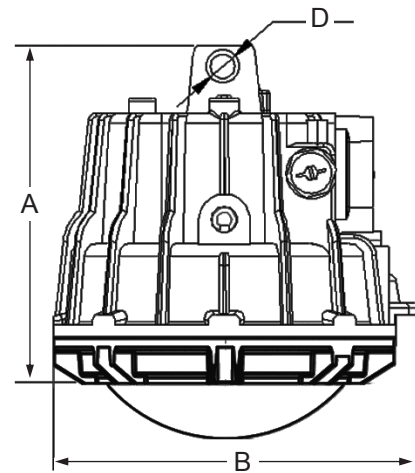
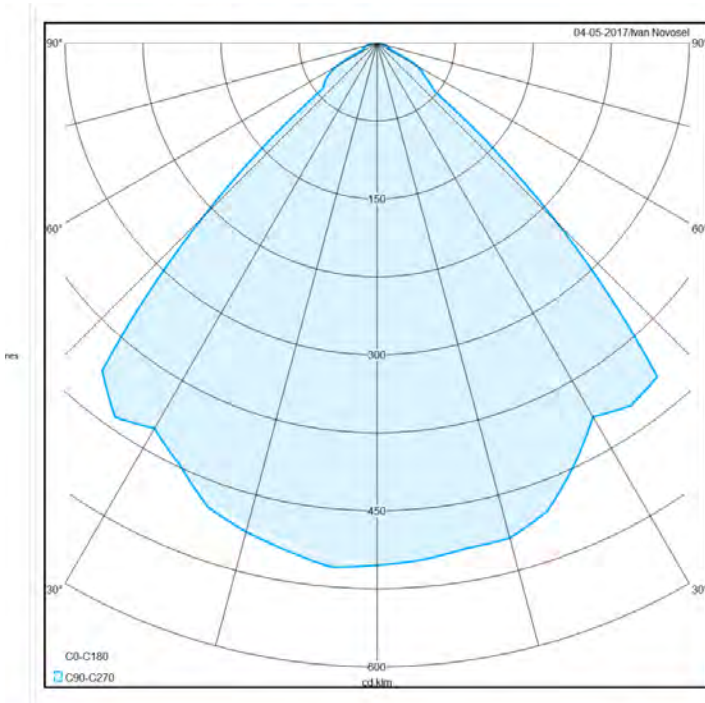

A	B	C	D
225	245	300	Ø16

SPARE PARTS AND ACCESSORIES

SKETCH	DESCRIPTION	CODE	SKETCH	DESCRIPTION	CODE
	Replacement glass PLFS LED	PLFS LED 10-120		PLFS-T fixing bracket for tube R 1 1/2"	PLFS 20-120
	Wire guard PLFS LED	PLFS LED 10-130		PLFS-T mounting bracket (ceiling and wall mounting)	PLFS 20-130

All technical data is relevant at the time of print.

LED

IP 66



IK08

T_a
C°
-40 +50

PLFS-N 100 LED



- Highest efficiency with luminous efficacy up to 170lm/W
- High color rendering index CRI 80
- Estimated service life 70 000 hours
- With OVP, OCP, OTP protection
- Autonomous reactivation after recovery
- CCT4000K / other CCT on request
- Frosted front glass on request

new
LED
more lm/W

CONSTRUCTION

Housing: aluminium powder painted casting

Diffuser: borosilicate glass,

Accessories: protected galvanized steel gird, assembly kit for wall, pipe and ceiling mounting

Gasket: silicon

TECHNICAL DATA

Certificate:	FIDI 19 ATEX 0031
Marking:	CE 0722
Apparatus category:	II 2G II 2D
Marking of explosion protection:	Ex db eb op is IIC T6 Gb Ex tb op is IIIC T80°C Db
Ambient temperature ATEX:	-40°C / -20°C ≤ T _a ≤ +40 / +50°C
Degree of protection:	IP 66 category 1
Resistance to shock:	IK 08
Protection class :	I (protective earthing)
Rated voltage:	90 - 305 V AC 127 - 431 V DC
Frequency:	50Hz / 60Hz
Rated power:	80W, 100W
Connecting terminals:	L1, L2, L3, N; max. 2 x 2,5 mm ² PE terminal ; max 2x6mm ²
Cable entry:	Connection box [3L+N+Pe] and true wiring + ISO20 metal plug 2x M20 (1x M20 Exd cable gland, 1x Exd M20 plug) ADP 23/1+ ISO20 metal plug
Weight:	9 kg
Packing:	The packing contains: 2 pcs 560 x 300 x 270 mm

MOUNTING

Pendant, on pipe, wall, ceiling

Pendant LED light fitting

MODEL CODE

MODEL CODE	LED POWER [W]	VOLTAGE [V]	LUMINOUS FLUX [lm]	LIGHT OUTPUT RATIO η	AMBIENT TEMP.
PLFS-N 100 LED-3	80 W	90-305 V AC 127-431 V DC	13 600	0,80	-40°C ÷ +50°C
PLFS-N 100 LED-4	100 W		17 000		-40°C ÷ +40°C

POLAR CURVE

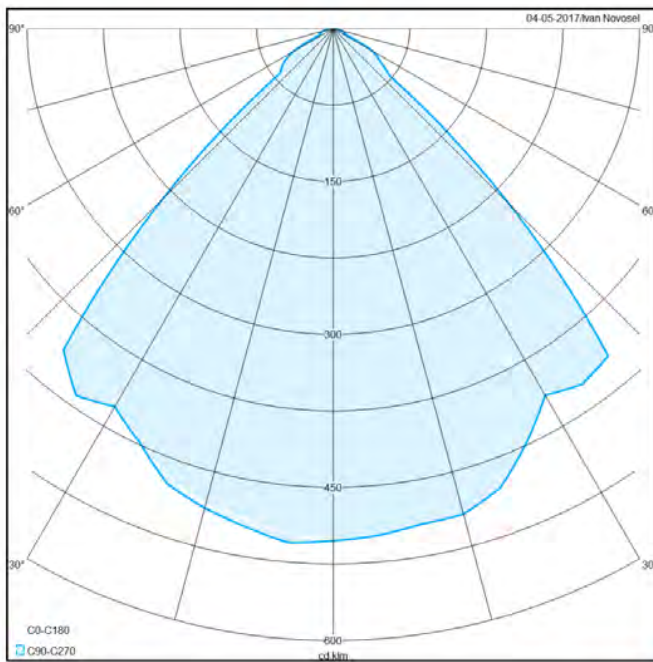

DIMENSION DRAWING (mm)

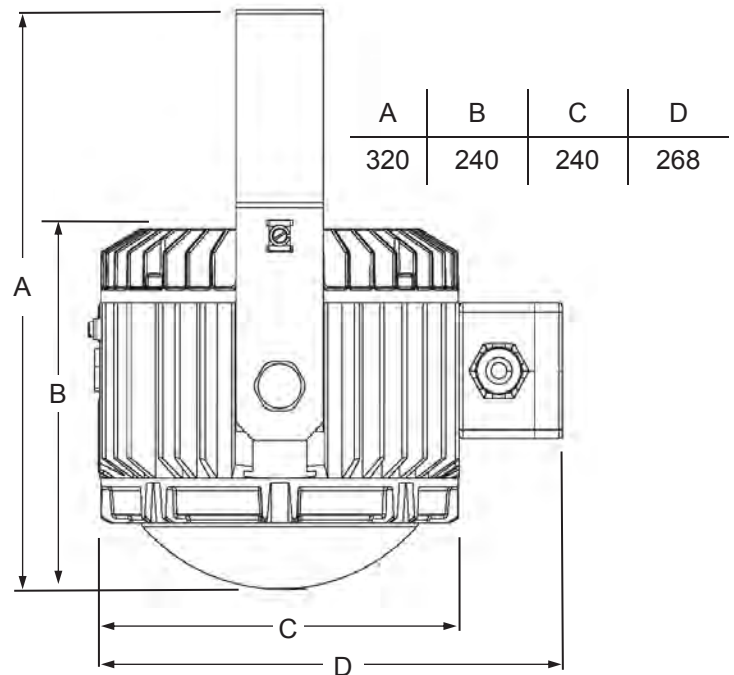

MULTI FLOODLIGHTS SOLUTION

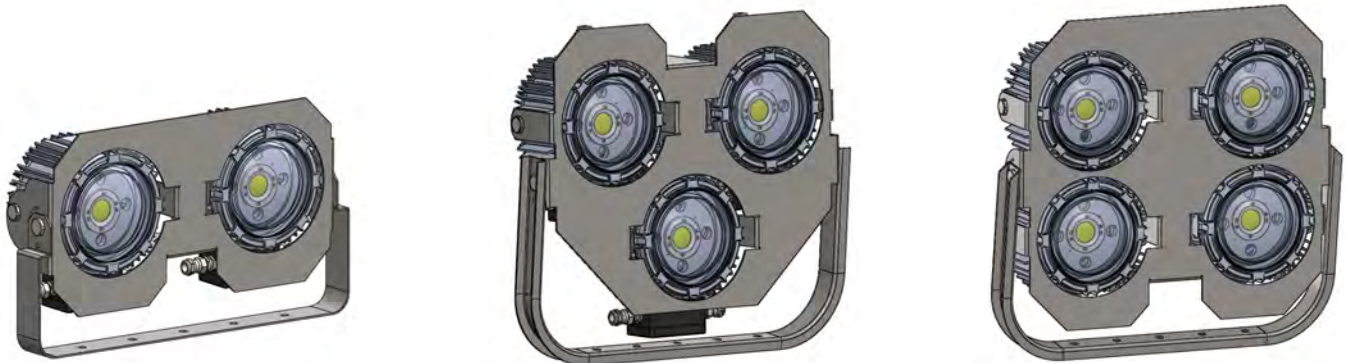

MODEL CODE	LED POWER [W]	VOLTAGE [V]	LUMINOUS FLUX [lm]	WEIGHT kg
PLFS-N 2100 LED	2x 80 W	90-305 V AC 127-431 V DC	27 000	22
PLFS-N 3100 LED	3x 80 W		40 000	34
PLFS-N 4100 LED	4x 80 W		54 000	45

SPARE PARTS AND ACCESSORIES

SKETCH	DESCRIPTION	CODE	SKETCH	DESCRIPTION	CODE
	Replacement glass PLFS-N LED	PLFS LED 10-120		PLFS-N fixing bracket for tube R 1 1/2"	PLFS 20-120
	Wire guard PLFS LED	PLFS LED 10-130		PLFS-N mounting bracket (ceiling and wall mounting)	PLFS 20-130

All technical data is relevant at the time of print.

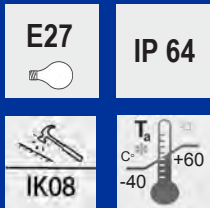

- Incandescent lamps up to 100 W and halogen lamps up to 77 W
- Through-wiring possible
- For use in underground mines



CONSTRUCTION

Housing: 0403.24/10, /11, /12 - aluminium powder painted casting
 0403.24/20 - cast iron
 Diffuser: borosilicate glass protected with steel grid

TECHNICAL DATA

Certificate:	FIDI 19 ATEX 0035X RU C-HR.AB24.B.03246
Marking:	CE 0722
Apparatus category:	II 2GD, I M2
Marking of explosion protection:	Ex d e IIC T3-T2 Gb Ex tb IIIC T130° Db Ex d e I Mb
Ambient temperature:	-40°C ≤ T _a ≤ +40/50/60°C - type II 2GD -20°C ≤ T _a ≤ +40°C - type I M2
Degree of protection:	IP 64, category 1 - type II 2GD IP 54, category 1 - type I M2
Resistance to shock:	IK 08
Protection class :	I (protective earthing)
Rated voltage:	230V AC, 110V AC, 24V AC/DC
Frequency:	50Hz (60Hz on request)
Rated power:	See selection table
Light output ratio:	η=0,68%
Lamps:	Incandescent lamps, E 27 lampholder, up to 100W Halogen lamps, E 27 lampholder, (77W A ECO)
Connecting terminals:	Terminals L1 + N for 2 x 4 mm ² flexible/solid Terminals PE for 2 x 4 mm ² flexible/solid/stranded Tightening torque for screw clamp 2,2 Nm
Cable entry:	1 x M25x1.5 cable gland (through-wiring possible) 1 x M25x1.5 plug
Cover fixing:	M 6, Hexagonal screw; without switch
Packing:	The packing contains: 1 pcs 360x240x205 mm



Bulkhead light fitting

MODEL CODE

Model code	Apparatus category	Explosion protection	Rated voltage	Max. wattage	Luminous flux	WEIGHT
0403.24/10	II 2G	Ex d e IIC T2, T3 Gb	230/110 V AC 230/110 V AC, 24 V AC/ DC 230 V AC	100W max. 60W max. 77W max. / A ECO	1500 lm 800 lm 1320 lm	3,8 kg
0403.24/11, 12 (signal red or green glass)		Ex d e IIC T3 Gb	230 V AC	40W max.	450 lm	3,8 kg
0403.24/20	I M2	Ex d e I Mb	230 V AC	100W max.	1500 lm	6 kg

POLAR CURVE

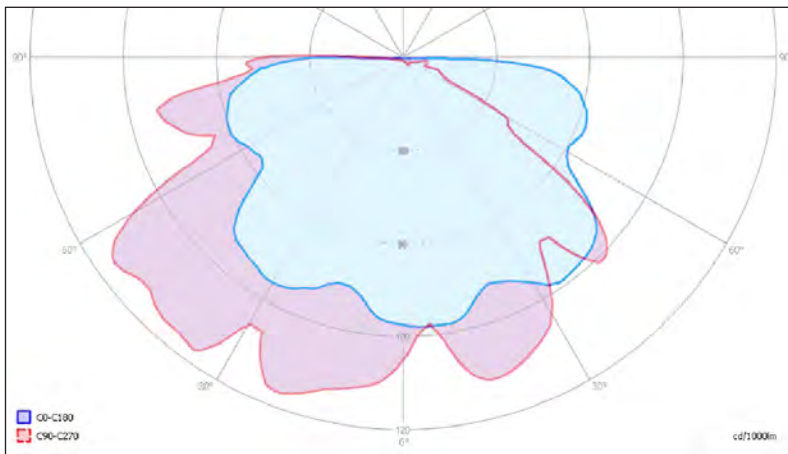

DIMENSION DRAWING (all dimensions are in mm)

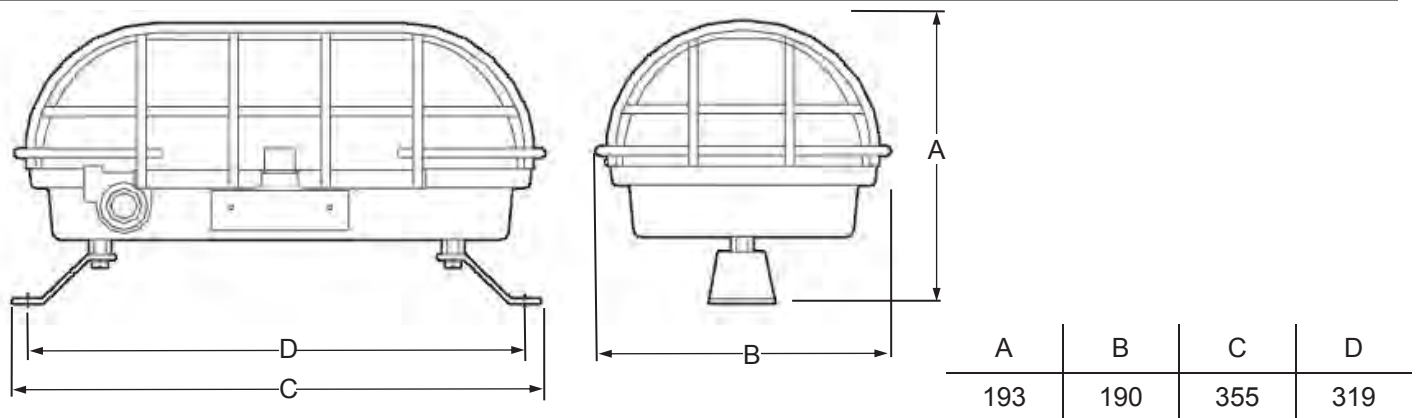

SPARE PARTS AND ACCESSORIES

Sketch	Description	Code	Sketch	Description	Code
	Ex d lampholder E27 set	0403.24 10-110		Ex e cable gland M25	SPU 25
	Gasket 0403.24	0403.24 10-120		II M2 Ex e I Cable gland	0403.24 20-120
	Replacement glass	0403.24 10-130		Ex e plug M25	SPC 25
	Light bulb 40W, 60W, 100W	0403.24 20-110		I M2 Ex e I Plug M25	0403.24 20-130

All technical data is relevant at the time of print.

E27



IP 66



IK08



- Low weight/3,5 kg
- Up to 70W HSE (5900 lm)

**CONSTRUCTION**

Housing: aluminium powder painted casting

Diffuser: borosilicate glass

Accessories: protected galvanized steel gird (INOX on request), assembly kit for wall, pipe and ceiling mounting

TECHNICAL DATA

Certificate:	FIDI 19 ATEX 0047 RU C-HR.AB24.B.03245
Marking:	CE 0722
Apparatus category:	II 2GD
Marking of explosion protection:	 Ex db eb IIC T6-T3 Gb Ex db IIC T6-T3 Gb Ex tb IIIC T80°C - T155°C Db
Ambient temperature:	-20°C ≤ T _a ≤ +40°C [ATEX] -50°C ≤ T _a ≤ +40°C [EAC]
Degree of protection:	IP 66, category 1
Resistance to shock:	IK 08
Protection class :	I (protective earthing)
Rated voltage:	230V AC PLFM FLASH - see model code table
Frequency:	50Hz (60Hz on request)
Rated power:	See model code table
Light output ratio:	η=0,75%
Cable entry:	Direct entry; 2 x M20x1.5 Indirect entry ; ADP 23/1, Ex e junction box, Ex d metal cable gland M20
Connecting terminals:	L, N, PE; max. 2 x 2,5 mm ² solid, flexible terminal for external -PA connection; max 2x6 mm ²
Weight:	3,5 kg → PLFM 100/., PLFM FLASH-. 4,5 kg → PLFM 20 LED-. , PLFM 70 HSE-.
Packing:	The packing contains: 2 pcs 340x260x170 mm

MOUNTING

Pendant, on pipe, wall, ceiling

Pendant light fitting

PLFM ... - .



Basic type code

Maximal wattage and type of sources

Type of entries:

- 1 – indirect entry – type with Ex e junction box,
- 2 – indirect entry – type with Ex d adapter ADP 23/1,
- 3 – direct entry – type with Ex d cable gland

MODEL CODE

Model code	Max. wattage	Lamp type	Nominal voltage	Luminous flux	Lamp holder	Temp. class	
						(gas) T _a =40°C	(dust) T ₀ MAX T _a =40°C
PLFM 100 - .	100 W	A	230V	1340 lm	E27	T4	130°C
	116 W Osram 105 W Philips	A ECO	230 V	2135 lm Osram 1980 lm Philips	E27	T4	130°C
	100 W	QT	230 V	1800 lm Osram	E27	T4	130°C
PLFM 100/1 - .	100 W	LME	230 V, 50 Hz	1100 lm	E27	T3	155°C
PLFM 100/2 - .	22 W Osram 23 W Philips	TC-SB	230 V, 50 Hz	1440 lm	E27	T6	80°C
PLFM 100/3 - .	12 W Osram 13 W Philips	LED	230 V, 50 Hz	810 lm Osram 1055 lm Philips	E27	T6	80°C
PLFM 20 LED - .	20 W	LED modul	230 V, 50 Hz	1300 lm	-	T6	80°C
PLFM FLASH - .	5 W	XENON	10–100 V DC	4J/90Hz	-	T6	80°C
			110 V AC				
			230 V AC				
PLFM 70 HSE - .	70 W	HSE	230 V, 50 Hz	5900 lm Osram 5600 lm Philips	E27	T4	130°C
	50W	HSE	230 V, 50 Hz	3600 lm Osram 3500 lm Osram	E27	T4	130°C



All technical data is relevant at the time of print.

POLAR CURVE

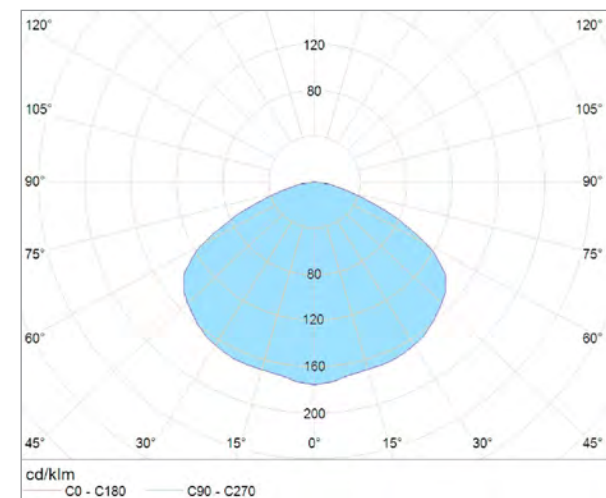

PLFM 100-., PLFM 70 HSE
With external reflector

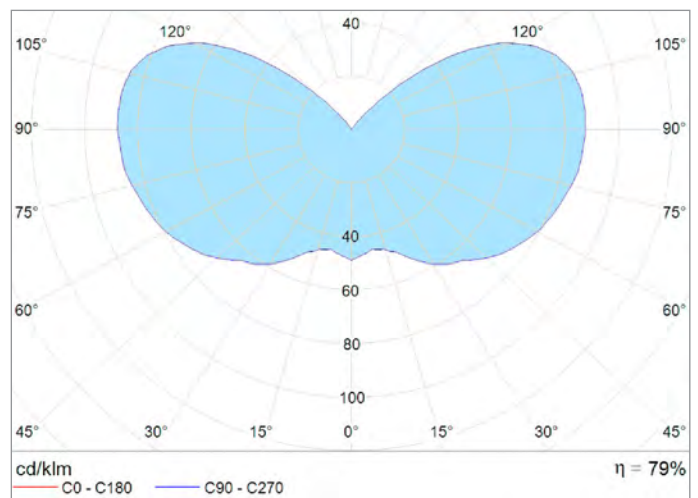

PLFM 100-., PLFM 70 HSE
Without external reflector

DIMENSION DRAWING (all dimensions in mm)

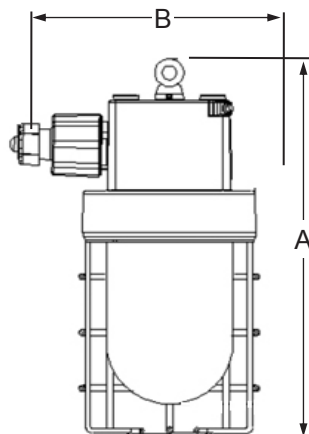
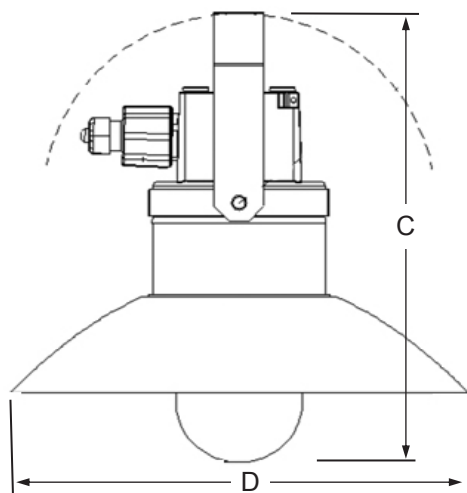

A	B	C	D
340	175	380	Ø370

SPARE PARTS AND ACCESSORIES

Sketch	Description	Code	Sketch	Description	Code
	Replacement glass PLFM	PLFM 10-120		Ex e cable gland M25	SPU 25
	Wire guard PLFM	PLFM 10-130		Ex e plug M25,	SPC 25
	Gasket PLFM	PLFM 10-140		Light bulb	According to type table
	Lampholder with internal reflector	PLFM 10-150		PLFM fixing bracket for tube R 2"	PLFM 20-120
	Ballast set	PLFM 10-170		PLFM mounting bracket (ceiling mounting)	PLFM 20-130
	Adapter ADP 23	PLFM 20-110		PLFM mounting bracket (wall mounting)	PLFM 20-140

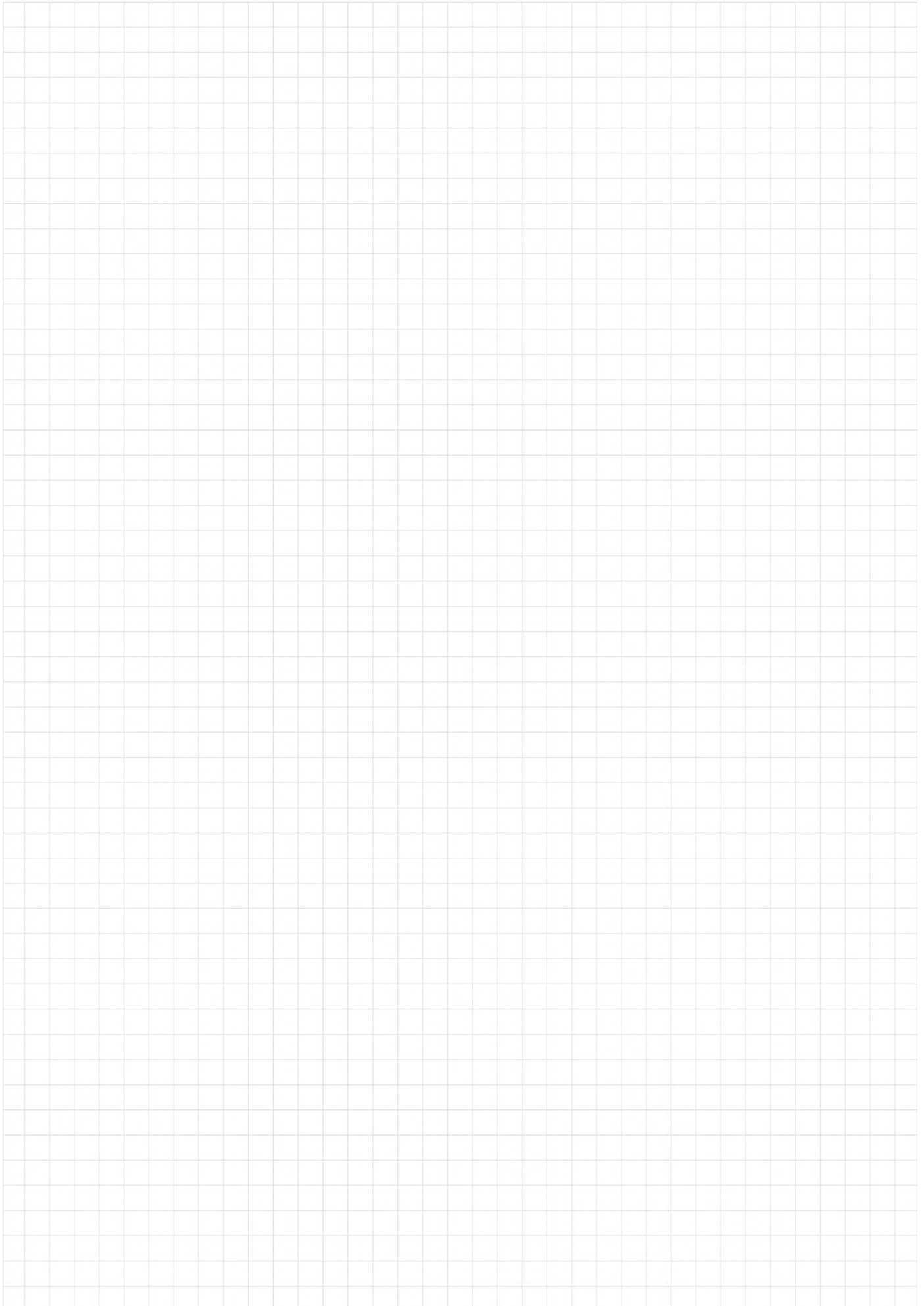

E27/E40



IP 66



IK08



PLFS-N



CONSTRUCTION

Housing: aluminium powder painted

Diffuser: borosilicate glass

Accessories: protected galvanized steel gird, assembly kit for wall, pipe and ceiling mounting

TECHNICAL DATA

Certificate:	FIDI 19 ATEX 0036 RU C-HR.AB.B.03244
Marking:	CE 0722
Apparatus category:	II 2GD
Marking of explosion protection:	 II 2G Ex db eb IIC T6-T3 Gb II 2G Ex db IIC T6-T3 Gb II 2D Ex tb IIIC T80°C – T195°C Db
Ambient temperature:	-40°C ≤ Ta ≤ +40°C / +50°C [ATEX] -50°C ≤ Ta ≤ +40°C / +50°C [EAC]
Degree of protection:	IP 66/67, category 1
Resistance to shock:	IK 08
Protection class :	I (protective earthing)
Rated voltage:	230 V (other voltage on request)
Frequency:	50Hz (60Hz on request)
Rated power:	See model code table
Light output ratio:	η=0,66% - 0,75%
Cable entry:	Direct entry; 2 x M25x1.5 Indirect entry ; ADP 23/1, Ex e junction box, Ex d metal cable gland M25
Connecting terminals:	L + N + PE, 0,5- 4mm ²
Weight:	8,6 kg
Packing:	The packing contains: 2 pcs 610x390x280 mm

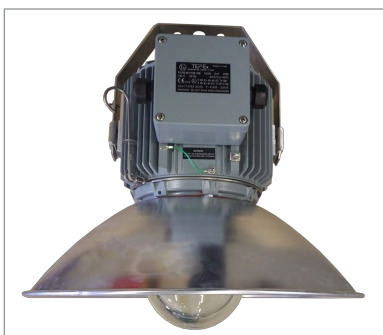
*PLFS-N external wide reflector*

- Heavy duty construction, aluminium enclosure and borosilicate glass

- Up to:

- 150W HIE
12500 lm
- 150 HSE (E40)
17000 lm

Pendant light fitting

MODEL CODE

Model code	Max. wattage and LBS (ZVEI) type of lamps	Lamp holder	Temp. class (gas)		T ₀ MAX (dust)		Luminous flux [lm]	
			T _a =40°C	T _a =50°C	T _a =40°C	T _a =50°C		
PLFS-N./30 TC-SB	30W TC-SB	E27	T6	-	80°C	-	2000	
PLFS-N./160 LME	160W LME		T5	T4	95°C	130°C	3100	
PLFS-N./150 QT	150W QT		T4	T4	130°C	130°C	2870	
PLFS-N./205 QT	205W QT		T3	-	195°C	-	4200	
PLFS-N./70 HSE/I	70W HSE/I		T5	T4	95°C	130°C	5900	
PLFS-N./125 HME	125W HME		T4	T4	130°C	130°C	6300	
PLFS-N./110 HSE	110W HSE Plug-in		T5	T4	95°C	130°C	8000	
PLFS-N./70 HIE,HSE	70W HIE		E27	T5	T4	95°C	130°C	5900
	70W HSE							6300
PLFS-N./100 HIE	100W HIE		E27	T5	T4	95°C	130°C	8075
PLFS-N./100 HIE,HSE	100W HIE	E40	T5	T4	95°C	130°C	-	
	100W HSE						10400	
PLFS-N./150 HIE	150W HIE	E27	T4	-	130°C	-	12100	
PLFS-N./150 HIE,HSE	150W HIE	E40	T4	-	130°C	-	-	
	150W HSE						17000	

POLAR CURVE

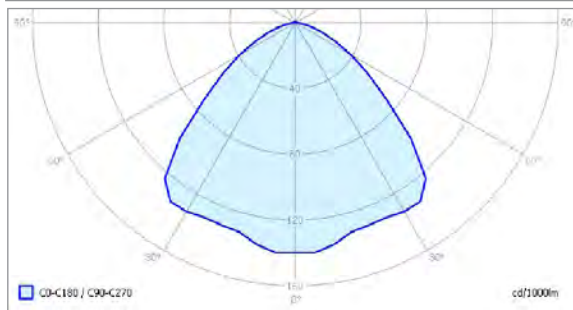

With external reflector

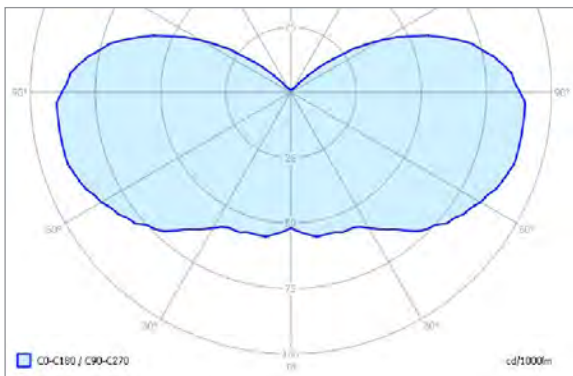

Without external reflector

DIMENSION DRAWING (all dimensions in mm)

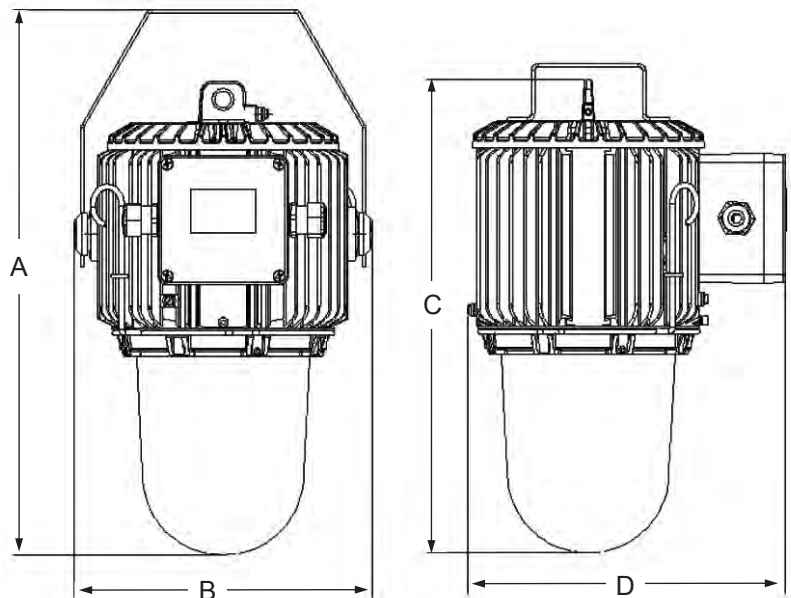

A	B	C	D
500	275	440	290

SPARE PARTS AND ACCESSORIES

Sketch	Description	Code	Sketch	Description	Code
	Replacement glass PLFS-N	PLFS-N 10-110		PLFS-N external reflector, wide	PLFS-N 20-140
	Wire guard PLFS-N	PLFS-N 20-110		PLFS-N fixing bracket for tube R 1 1/2"	PLFS-N 20-130
	Base plate with lamp holder, ballast	PLFS-N 10-130		PLFS-N mounting bracket (ceiling and wall mounting)	PLFS-N 20-120

All technical data is relevant at the time of print.

E40



IP 66



IK08



- Up to 250W discharge sources

**CONSTRUCTION**

Housing: aluminium powder painted casting

Diffuser: borosilicate glass

Accessories: protected galvanized steel gird, assembly kit for wall, pipe and ceiling mounting

TECHNICAL DATA

Certificate:	FIDI 19 ATEX 0069 RU C-HR.AB24.B.03247
Marking:	CE 0722
Apparatus category:	II 2GD
Marking of explosion protection:	Ex d e IIC T4-T3 Gb Ex d IIC T4-T3 Gb Ex tb IIIC T140°C - T155°C Db
Ambient temperature:	-20°C ≤ Ta ≤ +40°C / +50°C [ATEX] -50°C ≤ Ta ≤ +40°C / +50°C [EAC]
Degree of protection:	IP 66, category 1
Resistance to shock:	IK 08
Protection class :	I (protective earthing)
Rated voltage:	230 V (-10% / +6%) (other voltage on request)
Frequency:	50Hz (60Hz on request)
Rated power:	See model code table
Light output ratio:	η=0,53% - 0,77%
Cable entry:	two entries Ex d, M20x1,5-6H
Ex d adapter:	type ADP 23/1 cable gland ISO 25 for cable 7-15 mm
Connection terminals inside adapter, type PLFL-1/...	terminals for connection L + NE + PE; 2,5 mm ² , solid, stranded
Connection terminals inside light fitting	terminals for connection L + NE + PE; 2,5 mm ² , solid, stranded it is possible through wiring, I _{max} = 16 A
External PA / PE terminal:	max 2 x 6 mm ² flexible, 3 pcs.
Tightening torque:	housing of Ex d e adapter and Ex d plug 3,5 Nm pressure nut of cable gland 2,5 Nm screws of Ex e terminal 1,2 Nm
Weight:	ca 18 kg – PLFL-/500 A,IQ and PLFL/250 LME ca 23 kg - PLFL-/250 HIE, HSE, HME

MOUNTING

Pendant, on pipe, wall, ceiling

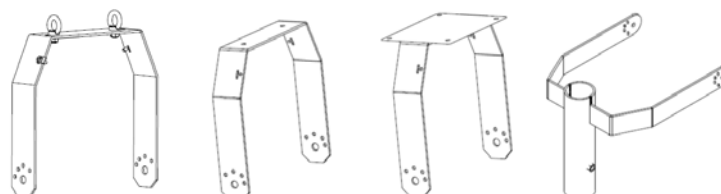

Pendant light fitting

MODEL CODE

Model code	Max. wattage	Lamp type	Luminous flux	Lamp holder	Temp. class (gas)		T ₀ MAX (dust)
					T _a =40°C	T _a =50°C	T _a =40°C
PLFL/250 HIE, HSE, HSE Twinarc	250 W	HIE	20000	E40	T4	T3	140°C
		HSE	28000				
		HSE Tw	32000				
PLFL/250 HME	HME	20000	-		-	-	
PLFL/250 LME	LME	5500					
PLFL/500 A,QT	A	8400					
	500 W	QT	10250				150°C

POLAR CURVE

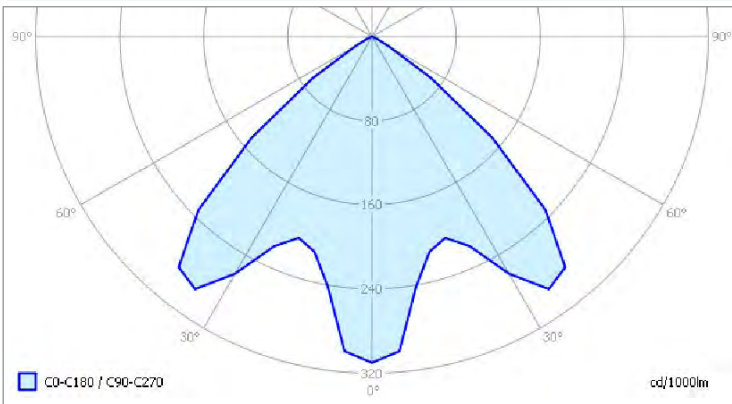

With external reflector

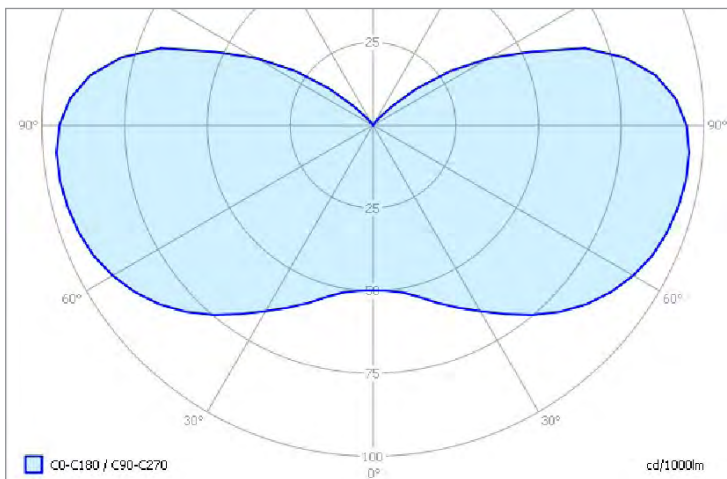

Without external reflector

DIMENSION DRAWING [mm]

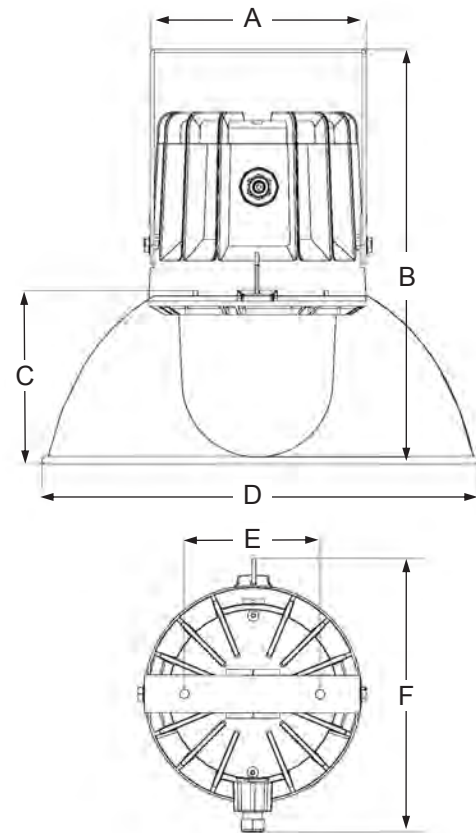

A	B	C	D	E	F
285	540	210	φ535	180	365

SPARE PARTS AND ACCESSORIES

Sketch	Description	Code	Sketch	Description	Code
	Replacement glass PLFL	PLFL 10-120		Gasket set PLFL	PLFL 10-160
	Wire guard PLFL	PLFL 10-130		PLFL external reflector	PLFL 20-100
	Base plate with lamp holder, ballast	PLFL 10-140		PLFL mounting bracket (ceiling and wall mounting)	PLFL 20-130
	Adapter ADP 23	PLFS-T 10-150		PLFL fixing bracket for tube R 1 1/2"	PLFL 20-120

All technical data is relevant at the time of print.

E40



IP 66



IK08



- Up to 400W discharge sources
- QL source up to 100 000 hours life time

**CONSTRUCTION**

Housing: aluminium powder painted casting

Diffuser: borosilicate tube glass

Accessories: protected galvanized steel gird, assembly kit for wall, pipe and ceiling mounting

TECHNICAL DATA

Certificate:	FIDI 19 ATEX 0049 RU C-HR.AB24.B.03248
Marking:	CE 0722
Apparatus category:	II 2GD
Marking of explosion protection:	 Ex db eb IIC T4-T3 Gb Ex db IIC T4-T3 Gb Ex tb IIIC T130°C - T195°C Db
Ambient temperature:	-20°C ≤ Ta ≤ +40°C [ATEX] -50°C ≤ Ta ≤ +40°C [EAC]
Degree of protection:	IP 66, category 1
Resistance to shock:	IK 08
Protection class :	I (protective earthing)
Rated voltage:	RLF/... HIT,HST,HME,QT -230/240 V (-10% / +6%) / 50 Hz
Frequency:	50Hz (60Hz on request)
Rated power:	See model code table
Light output ratio:	η=0,60%
Cable entry:	RLF/... HIT,HST,HME,QT - three entries M20, with two Ex d plug and one Ex de adapter, type ADP 23/1, for cable $\bar{\phi}$ 7-15 mm
Connection terminals inside light fitting	RLF/... HIT,HST,HME,QT -clamps in Ex d e adapter for connection L1, L2, N, PE, 2,5mm ² max. / clamp - solid, stranded;
External PA / PE terminal:	max 2 x 6 mm ² flexible, 3 pcs.
Weight:	See model code table
Packing:	The packing contains: 1 pcs 600x400x300 mm

MODEL CODE

Model code	Max. wattage	Lamp type	Luminous flux	Lamp holder	Temp. class (gas)	T ₀ MAX (dust)	Weight
					T _a =40°C	T _a =40°C	
RLF/250 HIT	250 W	HIE	20000	E40	T4	130°C	25 kg
RLF/250 HST		HST	33200				
RLF/250 HME		HME	13000				
RLF/400 HIT	400 W	HIE	34000		T3	190°C	27 kg
RLF/400 HST		HST	56500				
RLF/500 IQT	500 W	IQT	10 250				22 kg

POLAR CURVE

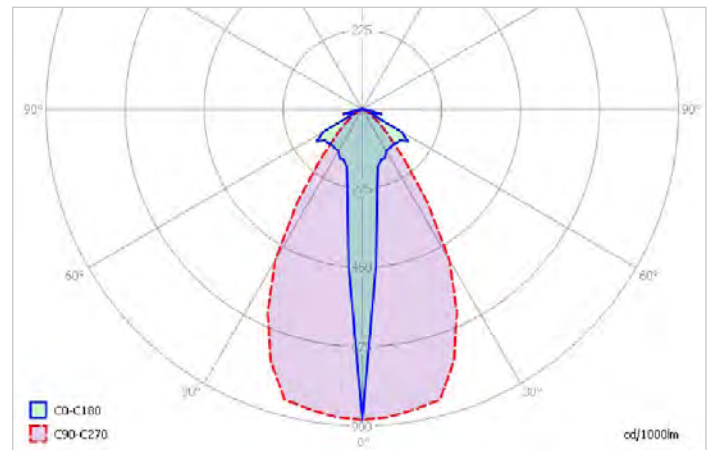
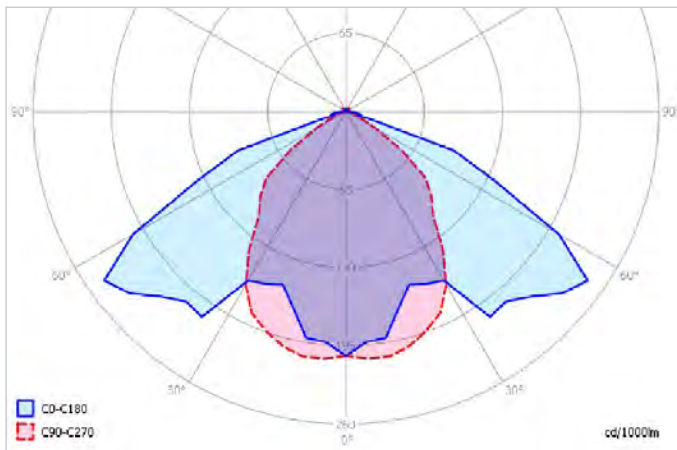



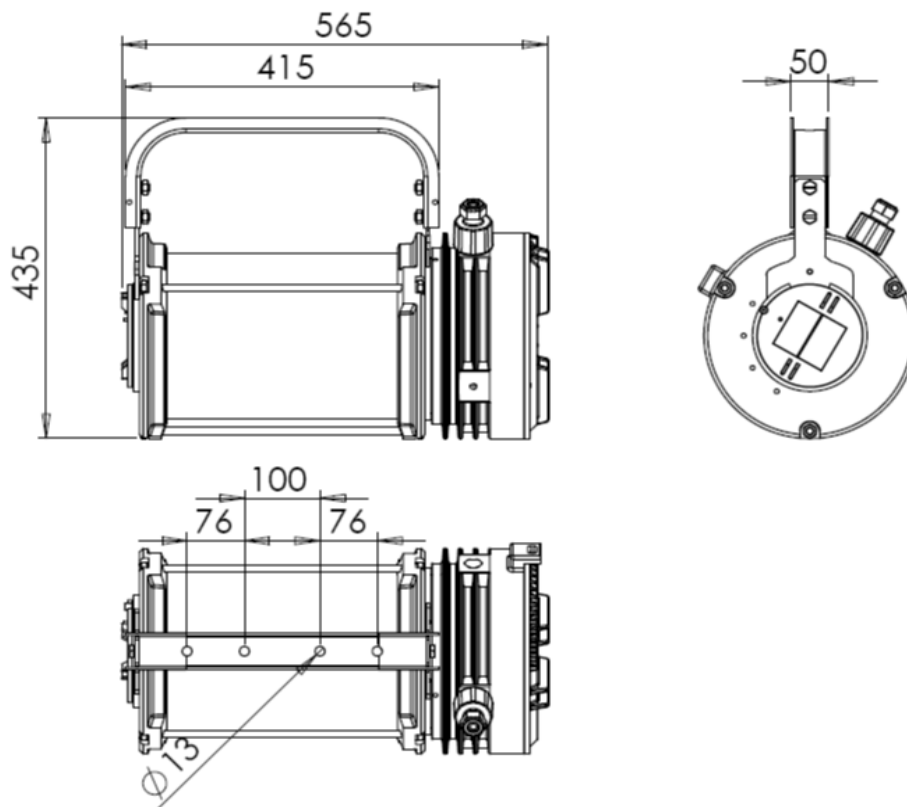





DIMENSION DRAWING (all dimensions in mm)



All technical data is relevant at the time of print.

SPARE PARTS AND ACCESSORIES

If it is not ordered differently, floodlight **RLF/ ... HIT,HST,HME,QT** presume floodlight with RLF carrier, one Ex de adapter ADP 23/1 and two Ex d plugs, without light source and mounting accessories. Manufacturer will deliver spare parts and accessories on buyer request.

Sketch	Description	Code	Sketch	Description	Code
	Light source	RLF 10-110		Base plate HME Set	RLF 20-120
	Mounting screw M12x40	RLF 10-120		Gasket RLF	RLF 20-130
	U screw M12	RLF 10-130		Adapter Ex d e	ADP 23/1
	Base plate HIT, HST Set	RLF 20-110		Ex d plug M20	RLF 20-140

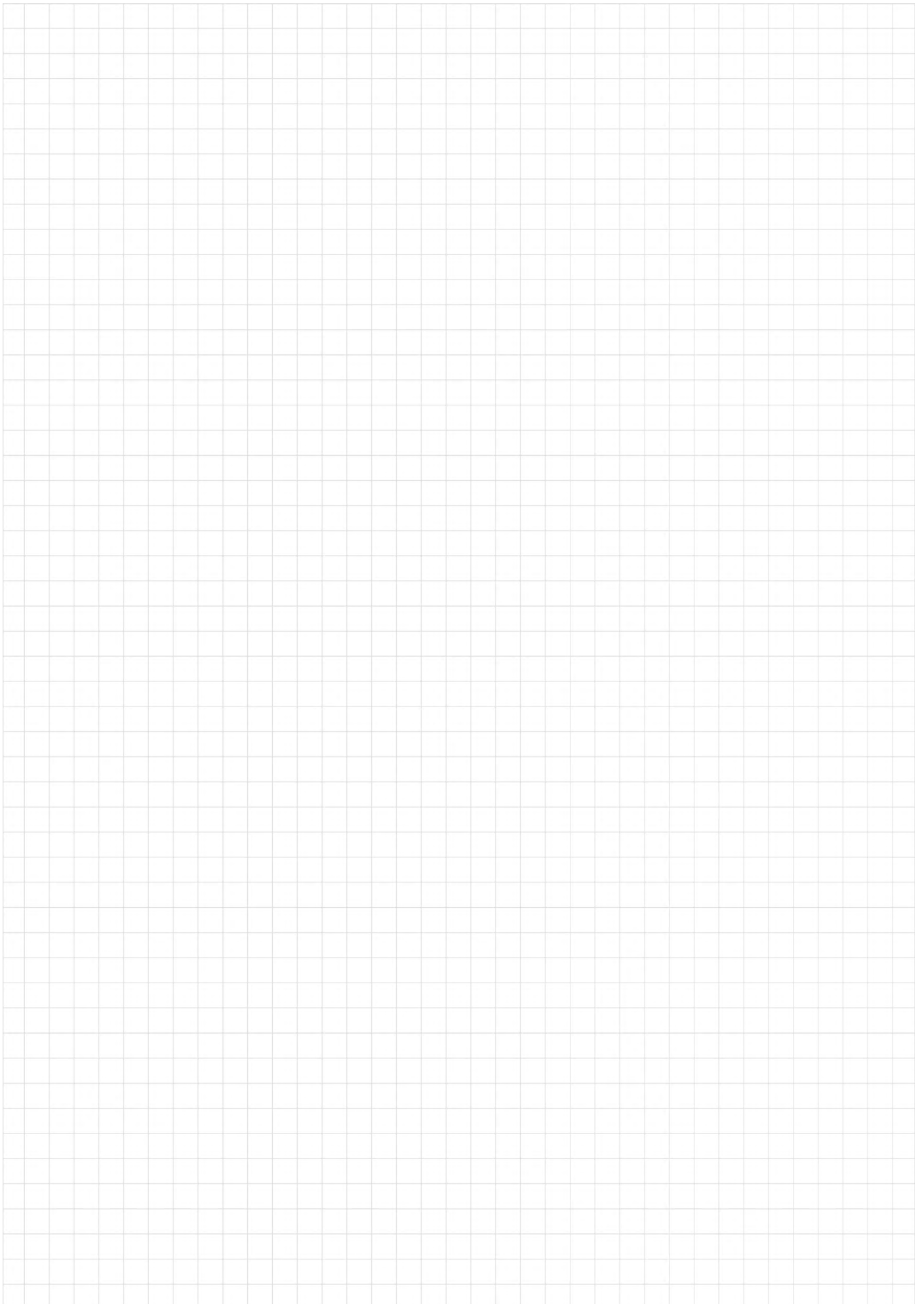



LED

IP 66



IK08



- Central locking with internal switch
- Through-wiring
- LED modules with innovative encapsulation
- Estimated service life up to 70 000 hours
- High color rendering index CRI 80
- Luminous efficacy 154lm/W
- With OVP, OCP, OTP protection
- Autonomous reactivation after recovery
- Color temperature: 4000K / other CCT on request
- DALI for controlling and monitoring the luminaire on request

PSF LED



CONSTRUCTION

Housing: SMC polyester plastic reinforced with glass fiber, color RAL 7038

Diffuser: PC polycarbonate plastic

Gasket: silicone

Central locking: can be opened/closed using a socket key SW8, hinged lamp cover

The light fitting is normally supplied with socket key, two Ex e cable glands M25, two Ex e plugs M25 and with mounting set PSF 30-110

TECHNICAL DATA

Certificate:	FIDI 19 ATEX 0029
Marking:	CE 0722
Apparatus category:	II 2G II 2D
Marking of explosion protection:	Ex db eb mb op is IIC T4 Gb Ex tb op is IIIA/IIIC T80°C Db
Ambient temperature:	-30°C ≤ T _a ≤ +55°C -30°C ≤ T _a ≤ +40°C
Degree of protection:	IP 66 category 1
Resistance to shock:	IK 08
Protection class :	I (protective earthing)
Rated voltage:	110-240 VAC / 220-250 VDC
Frequency:	50-60 Hz
Rated power:	See model code table
Estimated service life:	PSF 28 LED-1, PSF 52 LED-1 60 000 hours PSF 28 LED-2, PSF 52 LED-2 70 000 hours
Connecting terminals:	L1, L2, L3, N, PE - max. 2,5 mm ²
Cable entry:	Two entries Ex e M25x1,5 for cable diameters Ø6-15 mm, and two Ex e plugs
Packing:	The packing contains: 1 pcs PSF 52 LED: 1420x270x210 mm PSF 28 LED: 825x270x210 mm

MOUNTING

Pendant, on pipe, wall, ceiling



Liner LED without and with LED diffuser



Linear LED light fitting

MODEL CODE

MODEL CODE	LED POWER [W]	VOLTAGE [V]	LUMINOUS FLUX [lm]	LIGHT OUTPUT RATIO η	AMBIENT TEMP.	WEIGHT
PSF 28 LED-2	37 W	220-250VAC	5580 lm	0,84	$-30^{\circ}\text{C} \leq T_a \leq +40^{\circ}\text{C}$	8,0 kg
PSF 52 LED-2	70 W		11100 lm			12,0 kg

Version for the ambient temperature $T_a \leq +55^{\circ}\text{C}$

PSF 28 LED-1	28 W	220-250VAC	4600 lm	0,84	$-30^{\circ}\text{C} \leq T_a \leq +55^{\circ}\text{C}$	8,0 kg
PSF 52 LED-1	52 W		9100 lm			12,0 kg

POLAR CURVE

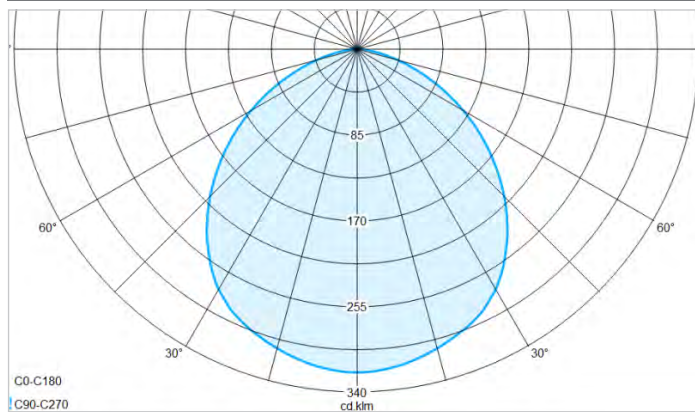

DIMENSION DRAWING (mm)

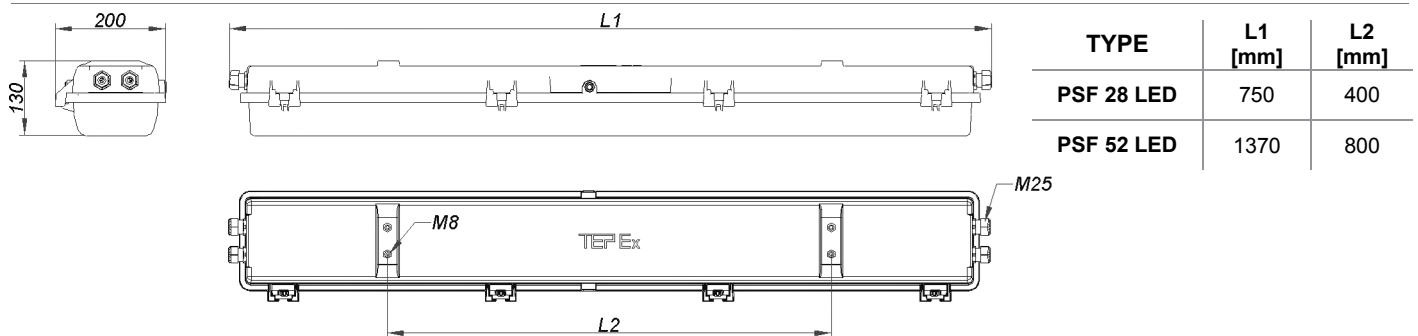

SPARE PARTS AND ACCESSORIES

SKETCH	DESCRIPTION	CODE	SKETCH	DESCRIPTION	CODE
	Diffuser PSF	PSF LED 28 10-120 PSF LED 52 20-120		PSF Ceiling mounting set	PSF 30-110
	Gasket PSF	PSF LED 28 10-130 PSF LED 52 20-130		PSF Pipe mounting set	PSF 30-120
	Internal reflector with LED module	PSF LED 28 10-140 PSF LED 52 20-140		PSF Wall mounting set	PSF 30-130
	LED driver	PSF LED 28 drive PSF LED 52 drive		Ring bolt M8	PSF 30-140
	LED diffuser	PSF LED 30-180		Socket key SW8	PSF236 20-160

All technical data is relevant at the time of print.



LED

IP 66



FLX 310 LED

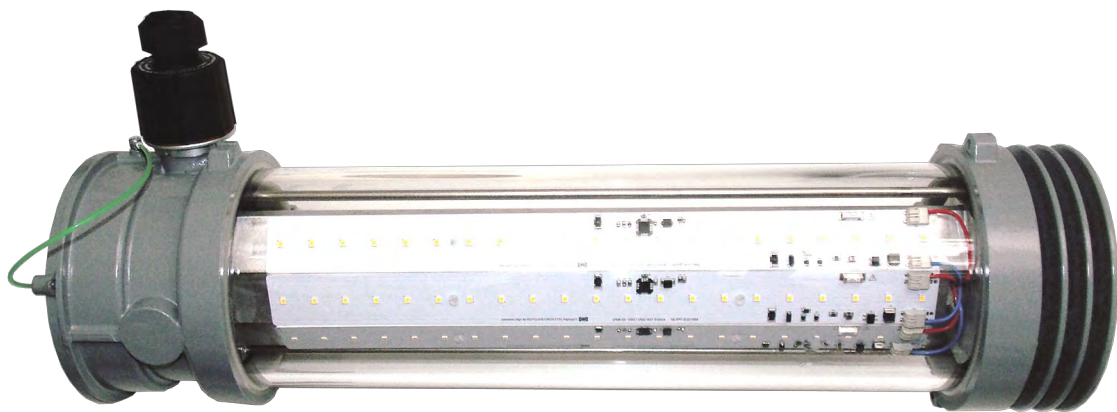

- High color rendering index CRI >80
- Estimated service life $\geq 50\,000$ working hours at $t_{amb} = 40^{\circ}\text{C}$
- LED 3 x 12W chip-on-board technology with OVP, OCP, OTP protection
- Autonomous activation after recovery
- Suitable for linear lighting up to 20 modules
- Color temperature: 4000K

Housing: aluminium powder painted casting
Diffuser: borosilicate glass tube,
Gasket: silicon

The light fitting is normally supplied with three LED linear sources, two entries M20 and wall/sealing mounting set

TECHNICAL DATA

Certificate:	FIDI 19 ATEX 0045X
Marking:	CE 0722
Apparatus category:	II 2G II 2D
Marking of explosion protection:	Ex db eb op is IIC T6 Gb Ex tb op is IIIC T80°C Db
Ambient temperature:	$-20^{\circ}\text{C} \leq T_a \leq +50^{\circ}\text{C}$
Degree of protection:	IP 66 category 1
Resistance to shock:	IK 08
Protection class :	I (protective earthing)
Rated voltage:	220-240 V 110V on request
Frequency:	50Hz / 60Hz
Rated power:	3x 12W
Connecting terminals:	L1, L2, L3, N; max. $2 \times 2,5 \text{ mm}^2$ PE terminal ; max $2 \times 6 \text{ mm}^2$ External PA terminal -PA; max $2 \times 6 \text{ mm}^2$
Cable entry:	2 x M20 or 2 x 3/4"NPT, with one Ex d plugs and one adapter type ADP 03/24 for cable $\phi 6-15 \text{ mm}$
Weight:	7kg
Packing:	The packing contains: 1 pcs 540x230x200 mm

MOUNTING

Pendant, on pipe, wall, ceiling mounting . Operates in any position.

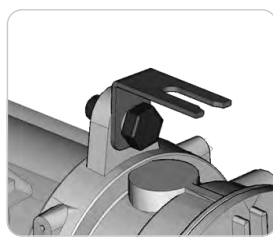

Linear LED light fitting

MODEL CODE

MODEL CODE	LED POWER [W]	VOLTAGE [V]	LUMINOUS FLUX [lm]	LIGHT OUTPUT RATIO η	AMBIENT TEMP.
FLX 310 LED	36W	220-240V	3600	0,85	-20°C + +50°C

DIMENSION DRAWING (mm)

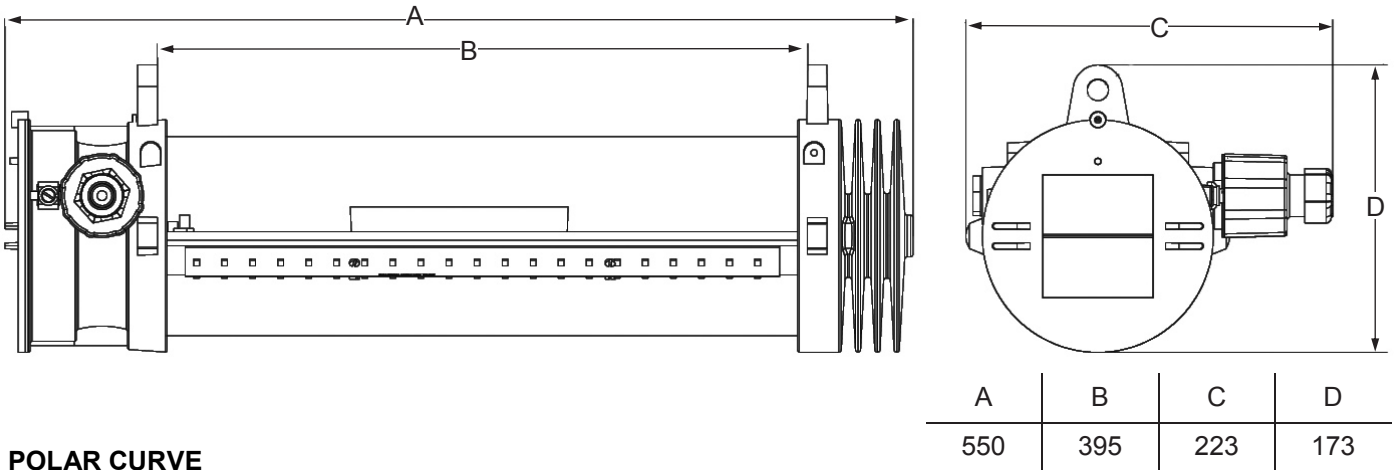

POLAR CURVE

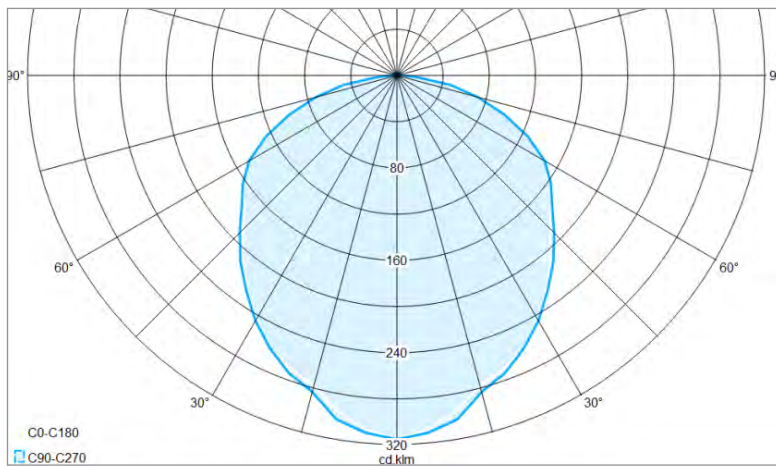

SPARE PARTS AND ACCESSORIES

SKETCH	DESCRIPTION	CODE	SKETCH	DESCRIPTION	CODE
	Cover gasket FLX	FLX1 0-120		External reflector FLX	FLX LED 20-150
	LED module FLX 310	FLX LED10-310		FLX Wall / ceiling mounting set	FLX 20-170
	Protective grid FLX set	FLX LED 20-140		FLX Pipe mounting set	FLX 20-180

All technical data is relevant at the time of print.



G13

IP 66

IK08

T_a
-30
+50

IM2

- T8 fluorescent lamps in parallel configuration
- Central locking
- Switch with safety lock; when opening the central lock, all poles of the voltage supply to the ballast are disconnected
- In case of a lamp fault, the electronic ballast disconnects the defective lamp from the power supply
- PSF 218 - use in underground mines



CONSTRUCTION

Housing: SMC polyester plastic reinforced with glass fiber

Diffuser: PC polycarbonate plastic

Gasket: silicone

Central locking: can be opened/closed using a socket key SW8, hinged lamp cover

The light fitting is normally supplied without light sources, socket key screw, two Ex e cable glands M25, two Ex e plugs M25 and with four ring screw M8 (pendant version).

TECHNICAL DATA

Certificate:	FIDI 19 ATEX 0025 , EAC RU C-HR.AB24.B.03249
Marking:	CE 0722
Apparatus category:	II 2GD, I M2 (type PSF 218)
Marking of explosion protection:	Ex db eb mb IIC T4 Gb Ex tb IIIA/IIIC T80°C Db, Ex db eb mb I Mb
Ambient temperature:	-30°C ≤ Ta ≤ +50°C [ATEX] -50°C ≤ Ta ≤ +40°C [EAC]
Degree of protection:	IP 66, category 1
Resistance to shock:	IK 08
Protection class :	I (protective earthing)
Rated voltage:	220...240 V (±10%)
Frequency:	50/60 Hz
Power factor:	λ=0,95
Ballast lumen factor:	98%
Light output ratio:	η=0,78%
End of life switch:	The electronic ballast, type SMP 07/12 fulfills the requirements according to EN 61349-2-3+A11:2017 ("end of life effect")
Estimated service life:	70 000 h at T _{amb} =40°C
Connecting terminals:	L1, L2, L3, N, PE - max. 2,5 mm ²
Cable entry:	Two entries Ex e M25x1,5 for cable diameters Ø6-15 mm, and two Ex e plugs
Through wiring:	5 x 1,5 mm ² , max. 16 A, or looping of the cables (entry and exit on one side)
Packing:	The packing contains: 1 pcs PSF 218 : 825x270x210 mm PSF 236 : 1420x270x210 mm PSF 258 : 1700x270x210 mm

MOUNTING

Pendant, on pipe, wall, ceiling



Fluorescent light fitting

MODEL CODE

Model code	Max. Wattage	Lamp type	Nominal voltage	Luminous flux [lm]	Lamp holder	Nominal operational current	Weight
PSF 218	2x18 W	T8	230 V	2 x 1350	G13	0,17 A	7,5 kg
PSF 236	2x36 W			2 x 3350		0,33 A	10 kg
PSF 258	2x58W			2x 5200		0,5 A	12 kg

POLAR CURVE

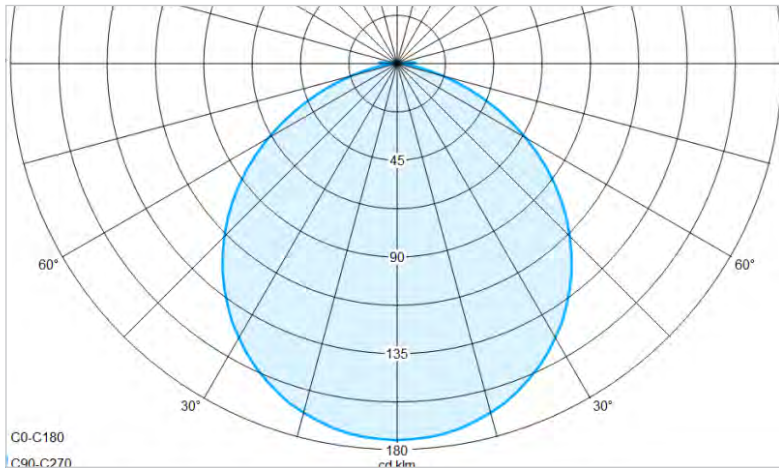

DIMENSION DRAWING (mm)

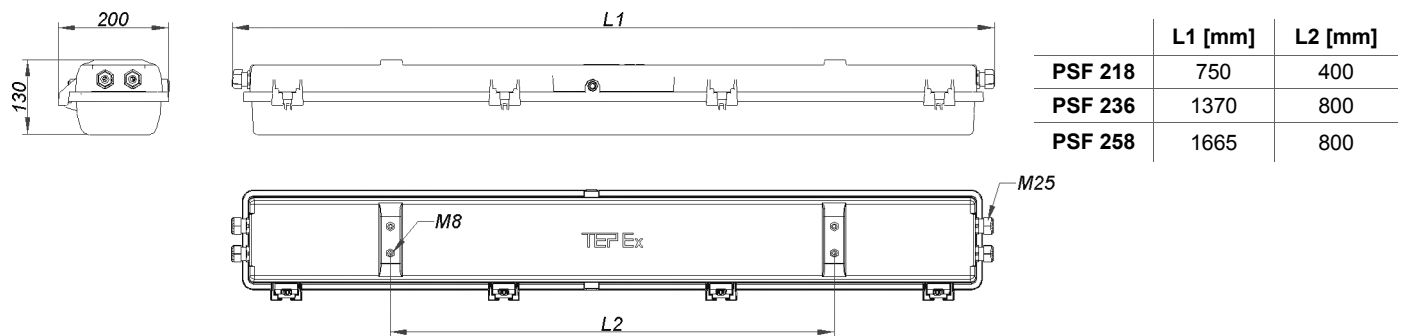

SPARE PARTS AND ACCESSORIES

Sketch	Description	Code	Sketch	Description	Code
	Diffuser PSF	PSF218 10-120 PSF236 20-120		Metal cable gland for arm cable	PSF 30-160
	Gasket PSF	PSF218 10-130 PSF236 20-130		Ex e plug M25	SPC 25
	Internal reflector with lamp holder PSF	PSF218 10-140 PSF236 20-140		PSF Ceiling mounting set	PSF 30-110
	El. ballast SMP	SMP 07/12 SMP 08 (PSF 258)		PSF Pipe mounting set	PSF 30-120
	Terminals 5x2,5mm ²	PSF236 20-150		PSF Wall mounting set	PSF 30-130
	Socket key SW8	PSF236 20-160		Ring bolt M8	PSF 30-140

All technical data is relevant at the time of print.



2G11

IP 66



IK08

-20
+40

- Robust light alloy enclosure
- Borosilicate tube glass
- TC-L fluorescent compact lamps
- 100÷280V AC/DC
- 0-60 Hz

FLX



CONSTRUCTION

Housing: aluminium, corrosion resistant grey polyurethanes painted

Diffuser: borosilicate glass tube

Gasket: silicon

The light fitting is normally supplied with two light sources, two entries M20 and wall/sealing mounting set.

TECHNICAL DATA

Certificate:	FIDI 19 ATEX 0027 , EAC RU C-HR.AB24.B.03253
Marking:	CE 0722
Apparatus category:	II 2GD
Marking of explosion protection:	 Ex db eb IIC T6 Gb / Ex db IIC T6 Gb Ex tb IIIC T80°C Db
Ambient temperature:	-20°C ≤ Ta ≤ +40°C [ATEX] -50°C ≤ Ta ≤ +50°C [EAC]
Degree of protection:	IP 66, category 1
Resistance to shock:	IK 08
Protection class :	I (protective earthing)
Rated voltage:	100 V ÷ 280 V AC/DC
Frequency:	0-60 Hz
Rated power:	See model code table
Ballast lumen factor:	98%
Light output ratio:	η=0,73%
Connecting terminals:	L1, L2, L3, N, PE - max. 2,5 mm ² PE for outside earthing max. 2 x 6 mm ²
Cable entry:	2 x M20 2 x 3/4"NPT 2 x M20, with one Ex d plugs and one adapter type ADP 03/24, for cable φ7-15 mm
Through wiring:	With two Ex de adapter ADP 03/24 - 4 x 2,5 mm ² , max. 16 A,

MOUNTING

Pendant, on pipe, wall, ceiling mounting



Fluorescent light fitting

MODEL CODE

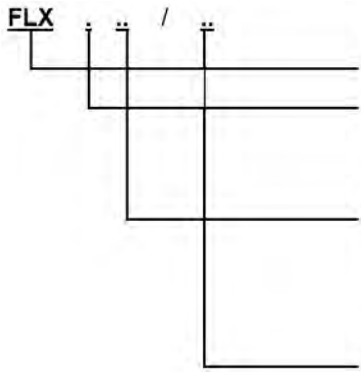

Basic marking code:

Number of fluorescent tubes:

- 1 – one tube
- 2 – two tubes

Power of fluorescent tubes :

- 18 - 18 W TC-L
- 36 - 36 W TC-L
- 55 - 55 W TC-L

Cable entry designation:

- 10 - Ex d cable entry 2 x M20
- 11 - Ex d cable entry 2 x 3/4"NPT
- 12 - Ex d cable entry 2 x M20 with one adapter type ADP 23/1 and one plug

Model code	Max. Wattage	Luminous flux [lm]	Weight
FLX 218	2x18 W	2 x 1200	4,6 kg
FLX 236	2x36 W	2 x 2900	5,8 kg
FLX 255	2x55 W	2 x 4700	8,0 kg

POLAR CURVE

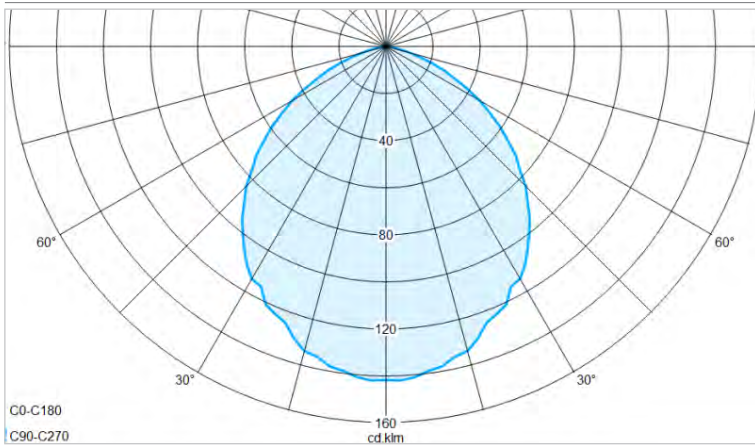

DIMENSION DRAWING (mm)

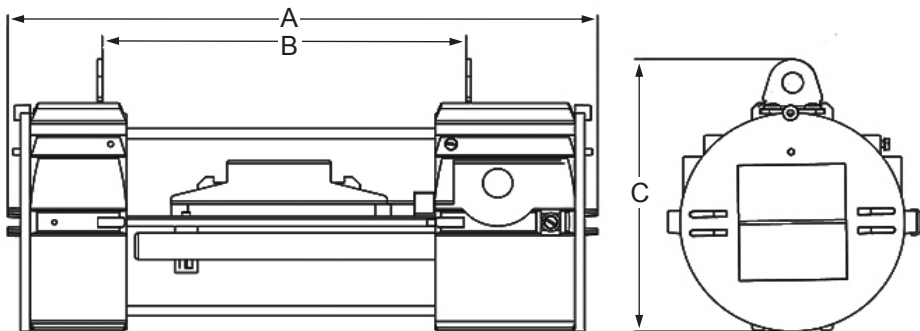

	A	B	C
FLX 218	366	225	174
FLX 236	555	416	
FLX 255	680	542	

SPARE PARTS AND ACCESSORIES

Sketch	Description	Code	Sketch	Description	Code
	Cover gasket FLX	FLX 10-120		FLX Wall / ceiling mounting set	FLX 20-170
	Base plate FLX/...	FLX 10-130		FLX Pipe mounting set	FLX 20-180
	Protective grid FLX set	FLX 20-140		External reflector FLX	FLX 20-150

All technical data is relevant at the time of print.



G13



IP 66



IK08



-20 +50



- T8 fluorescent lamps in parallel configuration
- Switch with safety lock; when opening the central lock, all poles of the voltage supply to the ballast are disconnected
- In case of a lamp fault, the electronic ballast disconnects the defective lamp from the power supply
- Recessed mounting set for clear rooms

SIF



CONSTRUCTION

Housing: Epoxy/polyester powder-coated sheet steel

Diffuser: flat borosilicate glass with a high thermal and mechanical stability

Gasket: EPDM formed gasket

All-pole are disconnected via NC switch when glass cover is opened.

The light fitting is normally supplied without light sources, two Ex e cable glands M25, one Ex e plug M25 and with two ring screw M8 (pendant version).

TECHNICAL DATA

Certificate:	FIDI 19 ATEX 0048
Marking:	CE 0722
Apparatus category:	II 2GD
Marking of explosion protection:	Ex db eb mb IIC T4 Gb Ex tb IIIC T80°C Db
Ambient temperature:	-20°C ≤ Ta ≤ +50°C
Degree of protection:	IP 66, category 1
Resistance to shock:	IK 08
Protection class :	I (protective earthing)
Rated voltage:	230 V
Frequency:	50/60 Hz
Power factor:	λ=0,95
Ballast lumen factor:	98%
Light output ratio:	η=0,72%
End of life switch:	The electronic ballast, type SMP 07/12 fulfills the requirements according to IEC 61347-2-3 (simulation of the "end of life effect" of fluorescent lamps
Estimated service life:	70 000 h at T _{amb} =40°C
Connecting terminals:	Terminal L1+L2+L3+ N + PE; max 3 x 4 mm ² , Terminal for protective earthing -PE; max 2 x 6 mm ² Terminal for external grounding, equipotential bounding , max 2 x 6 mm ²
Cable entry:	Two entries Ex e M25x1,5 for cable diameters Ø6-15 mm, and two Ex e plugs
Through wiring:	5x terminals 4x4 mm ² , max. 16 A, or looping of the cables (entry and exit on one side)
Disconnection of the light:	Switch with safety lock; when opening the central lock, all poles of the voltage supply to the ballast are disconnected
Packing:	The packing contains: 1 pcs 142X415X140 mm

MOUNTING Pendant, wall/ceiling mounting, recessed

Fluorescent light fitting

MODEL CODE

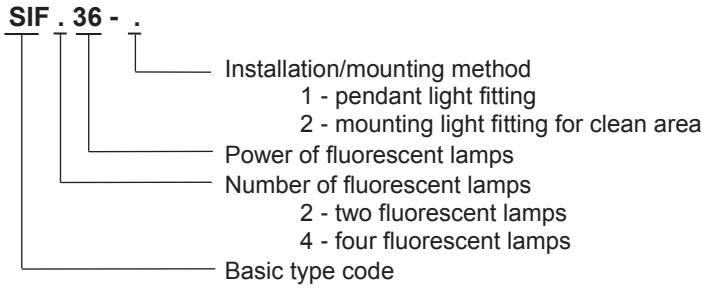

POLAR CURVE

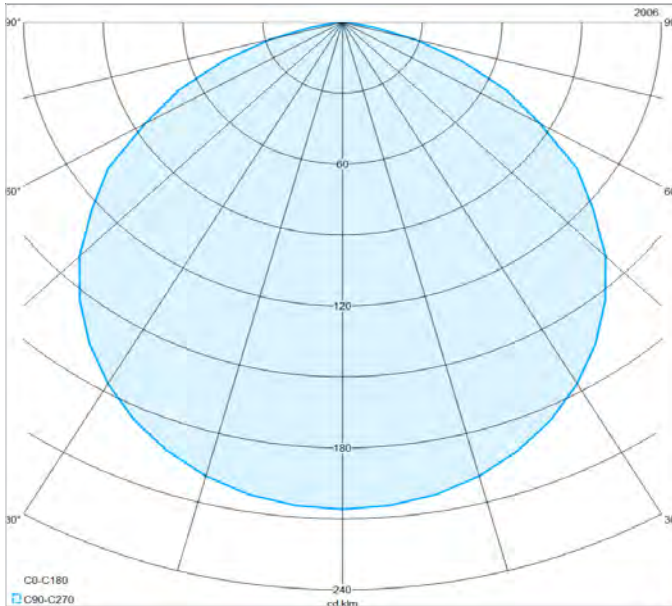

RECESSED LIGHT FITTING



DIMENSION DRAWING (mm)

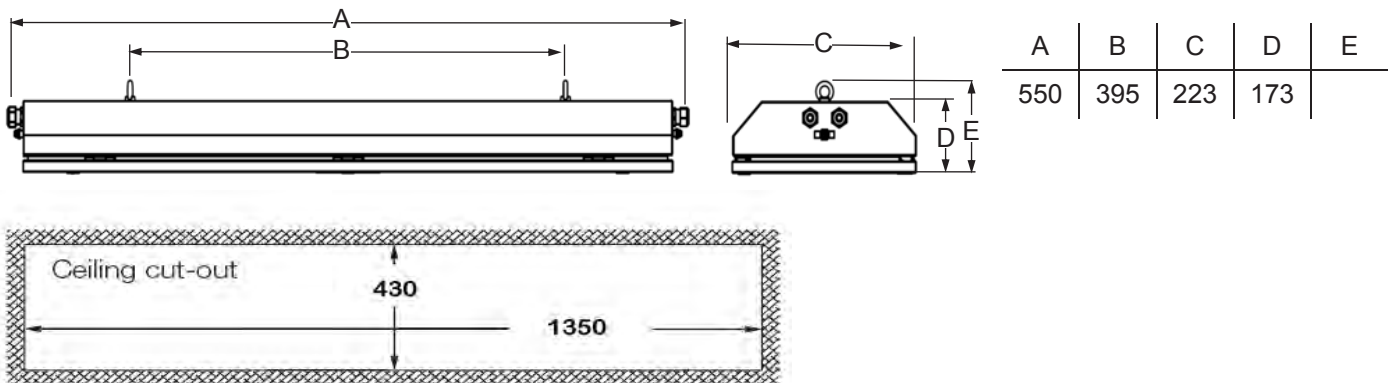

SPARE PARTS AND ACCESSORIES

Sketch	Description	Code	Sketch	Description	Code
	Gasket SIF	SIF 10-130		Glass cover SIF	SIF 10-140
	El. ballast SMP 07/12	SMP 07/12		Wall mounting set on 45°	SIF 20-140
	Ring bolt M8	-		Recessed mounting set	SIF 20-150

All technical data is relevant at the time of print.

LED

IP 66



FLXE 118 LED



CONSTRUCTION

Housing: aluminium powder painted casting

Diffuser: borosilicate glass tube,

Gasket: silicon

The light fitting is normally supplied with two entries M20 and wall/sealing mounting set

TECHNICAL DATA

Certificate:	FIDI 19 ATEX 0028 EAC RU C-HR.AB24.B.03252
Marking:	CE 0722
Apparatus category:	II 2G II 2D
Marking of explosion protection:	Ex db eb op is IIC T6 Gb Ex tb op is IIIC T80°C Db
Ambient temperature:	-20°C ≤ T _a ≤ +40°C / +50°C
Degree of protection:	IP 66 category 1
Resistance to shock:	IK 08
Protection class :	I (protective earthing)
Rated voltage:	220-240 V 24V, 110V AC/DC on request
Frequency:	50Hz / 60Hz
Rated power:	2W battery operation / 5W mains supply operation
Luminous flux:	200lm / 400lm
Connecting terminals:	L1, L2, L3, N; max. 2 x 2,5 mm ² PE terminal ; max 2x6mm ² External PA terminal -PA; max 2x6mm ²
Cable entry:	2 x M20 or 2 x 3/4"NPT or 2 x M20, with one Ex d plugs and one adapter type ADP 03/24 for cable φ6-15 mm
Weight:	4kg

MOUNTING

Pendant, on pipe, wall, ceiling mounting . Operates in any position.

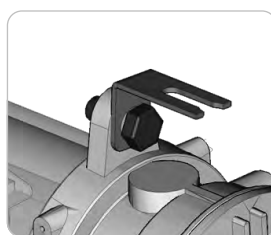

- Used for marking escape routes and exits in potentially explosive atmospheres.
- Self-test, monitoring and diagnostics reduce costly maintenance checks.
- >3h autonomy
- Maintained / Non maintained operation
- Possibility of supplies with DALI compatible ballast
- Ni-MH 3,6V/2.2Ah, build in light fitting, microprocessor controlled charging, discharging and control of battery

Emergency LED light fitting

MODEL CODE

FLXE 118 LED

Pictogram

0	Without	5	
1		6	
2		7	
3		8	
4			

Cable entry:

- 0 ... Ex d cable entry 2 x M20x1,5
- 1 ... Ex d cable entry 2 x 3/4" NPT
- 2 ... Ex de adapter ADP 24 (for cable 6-15mm)
- 3 ... 2x Ex de adapters ADP 24 (for cable 6-15mm)

Rated voltage:

- 0 ... 24 V AC
- 1 ... 24 V DC
- 2 ... 110 - 127 V AC/DC
- 3 ... 220 - 240 V AC/DC

The lamp can operate with two types of connection:

- Maintained (Dauerschaltung)
- Non maintained (Bereitschaftschaltung)

ISOCANDELA CURVE [I/cd]

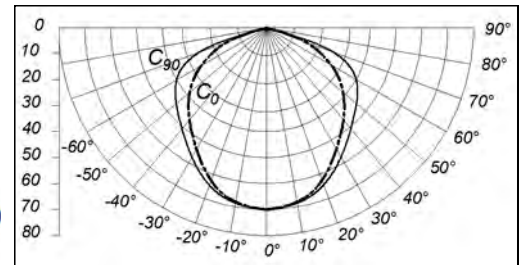



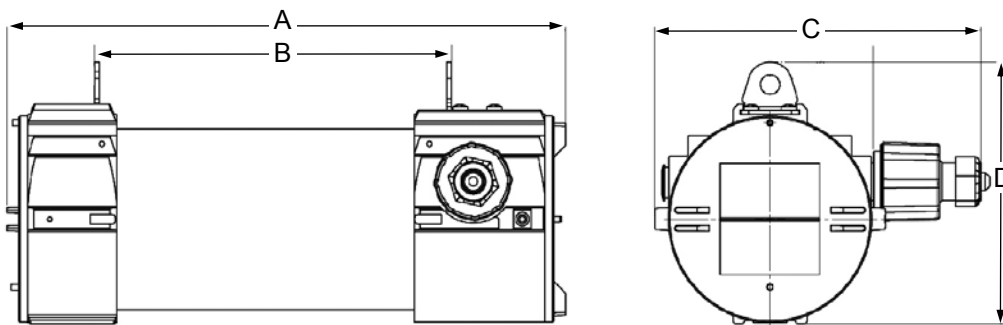



DIMENSION DRAWING (mm)

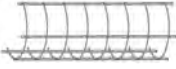

A	B	C	D
375	240	220	174

SPARE PARTS AND ACCESSORIES

SKETCH	DESCRIPTION	CODE	SKETCH	DESCRIPTION	CODE
	Cover gasket FLX	FLX 10-120		External reflector FLX	FLX LED 20-150
	Base plate FLXE	FLXE 10-130		FLX Wall / ceiling mounting set	FLX 20-170
	Protective grid FLXE set	FLXE 20-140		FLX Pipe mounting set	FLX 20-180

All technical data is relevant at the time of print.

LED

IP 66



IK08



PSF LED / PSF LED-E



CONSTRUCTION

Housing: SMC polyester plastic reinforced with glass fiber, color RAL 7038

Diffuser: PC polycarbonate plastic

Gasket: silicone

Central locking: can be opened/closed using a socket key SW8, hinged lamp cover

The light fitting is normally supplied with socket key, two Ex e cable glands M25, two Ex e plugs M25 and with mounting set PSF 30-110

TECHNICAL DATA

Certificate:	FIDI 19 ATEX 0029
Marking:	CE 0722
Apparatus category:	II 2G II 2D
Marking of explosion protection:	Ex db eb mb op is IIC T4 Gb Ex tb op is IIIC T80°C Db
Ambient temperature:	-20°C ≤ T _a ≤ +40°C
Degree of protection:	IP 66 category 1
Resistance to shock:	IK 08
Protection class :	I (protective earthing)
Operating voltage:	220-240V
Frequency:	50/60 Hz
Rated power:	See model code table
Estimated service life:	T _a ≤ +20°C > 130 000h T _a ≤ +30°C > 100 000h T _a ≤ +40°C > 50 000h
Connecting terminals:	L1, L2, L3, N, PE - max. 2,5 mm ²
Cable entry:	Two entries Ex e M25x1,5 for cable diameters Ø6-15 mm, and two Ex e plugs
Battery:	NiCd, 4,8V/4Ah
Nominal autonomy:	1,5h or 3h
Packing:	The packing contains: 1 pcs PSF 52 LED: 1420x270x210 mm PSF 28 LED: 825x270x210 mm

MOUNTING

Pendant, on pipe, wall, ceiling



- Central locking with internal switch
- Through-wiring possible
- LED modules with innovative encapsulation
- Estimated service life up to 70 000 hours
- High color rendering index CRI 80
- Luminous efficacy 154lm/W
- With OVP, OCP, OTP protection
- Autonomous reactivation after recovery
- Color temperature: 4000K

Linear LED light fitting

MODEL CODE

MODEL CODE	LED power [W]	VOLTAGE [V]	LUMINOUS FLUX [lm]	3h autonomy LUM [lm]	WEIGHT
PSF 28 LED-E	26 W	220-230VAC	4550 lm	1400 lm	9,0 kg
PSF 52 LED-E	56 W		9625 lm	1400 lm	13,0 kg

POLAR CURVE

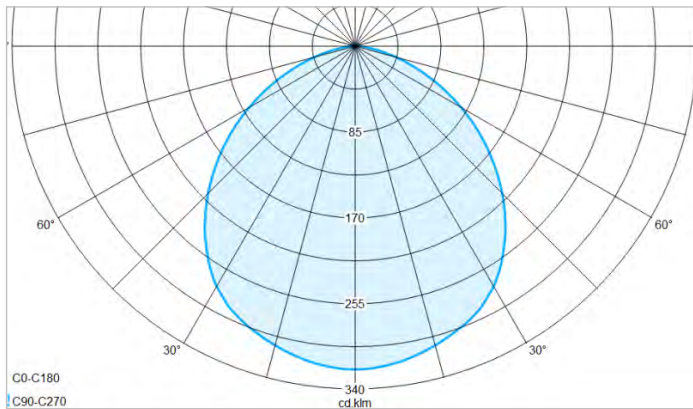

DIMENSION DRAWING (mm)

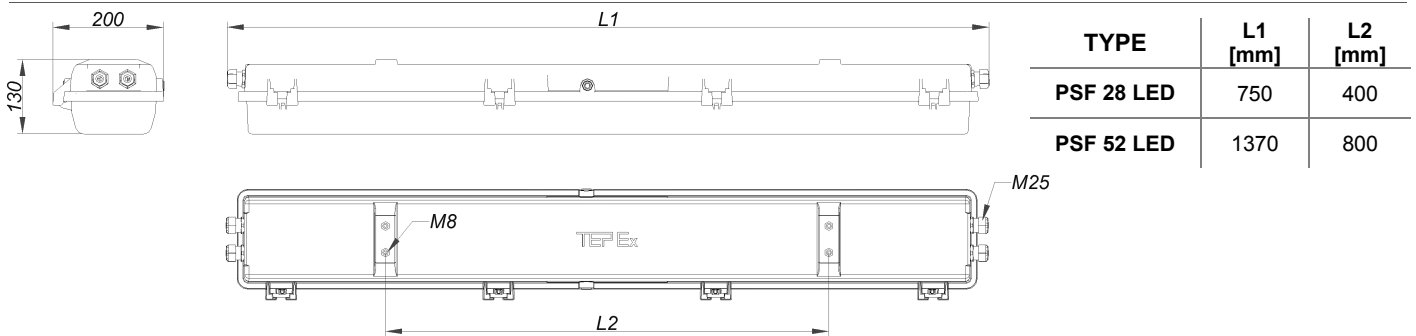

SPARE PARTS AND ACCESSORIES

SKETCH	DESCRIPTION	CODE	SKETCH	DESCRIPTION	CODE
	Diffuser PSF	PSF LED 28 10-120 PSF LED 52 20-120		PSF Ceiling mounting set	PSF 30-110
	Gasket PSF	PSF LED 28 10-130 PSF LED 52 20-130		PSF Pipe mounting set	PSF 30-120
	Internal reflector with LED module	PSF LED 28 10-140 PSF LED 52 20-140		PSF Wall mounting set	PSF 30-130
	LED EM driver	DRIVEx 02		Ring bolt M8	PSF 30-140
	LED difuzor	PSF LED 30-180		Battery module	BATEX 02

Liner LED without and with LED diffuser



All technical data is relevant at the time of print.

G13



IP 66



- 1,5 or 3h autonomy
- Maintained / Non maintained operation
- Ni-Mh battery

PSF E



CONSTRUCTION

Housing: SMC polyester plastic reinforced with glass fiber

Diffuser: PC polycarbonate plastic

Gasket: silicone

Central locking: can be opened/closed using a socket key SW8, hinged lamp cover

The light fitting is normally supplied without light sources, with socket key, two Ex e cable glands M25, two Ex e plugs M25 and with four ring screw M8 (pendant version).

TECHNICAL DATA

Certificate:	EXA 13 ATEX 0014/3
Marking:	CE 0722
Apparatus category:	II 2GD
Marking of explosion protection:	Ex db eb mb IIC T4 Gb Ex tb IIIC T80°C Db
Ambient temperature:	-20°C ≤ Ta ≤ +40°C
Degree of protection:	IP 66, category 1
Resistance to shock:	IK 08
Protection class :	I (protective earthing)
Rated voltage:	220...240 V (±10%)
Frequency:	50/60 Hz
Power factor:	λ=0,95
Ballast lumen factor:	98%
Light output ratio:	η=0,78%
Battery:	PSF 218E - Ni-Mh Saft VHT D, 4,8V 6Ah PSF 236E - Ni-Mh Saft VHT F, 4,8V 10Ah
Nominal autonomy:	1,5 / 3 hours
Connecting terminals:	L1, L2, L3, N, PE - max. 2,5 mm ²
Cable entry:	Two entries Ex e M25x1,5 for cable diameters Ø6-15 mm, and two Ex e plugs
Piktogram:	300x150mm
Packing:	The packing contains: 1 pcs PSF 236 : 1420x270x210 mm PSF 218 : 825x270x210 mm

MOUNTING

Pendant, on pipe, wall, ceiling



Emergency fluorescent light fitting

MODEL CODE

Model code	Max. Wattage	Nominal voltage	Luminous flux [lm]	Luminous flux bat. mod [lm]	Nominal operational current	Weight
PSF 218 E	2x18 W	230 V	2 x 1350	1,5h 60% (800lm) 3h 40% (550lm)	0,18 A	9,0 kg
PSF 236 E	2x36 W		2 x 3350	1,5h 60% (2000lm) 3h 30% (1000lm)	0,33 A	12,5 kg

POLAR CURVE

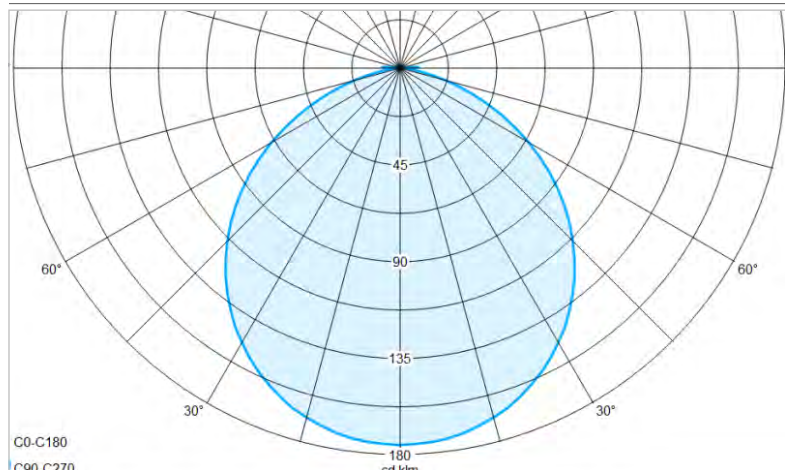

DIMENSION DRAWING (mm)

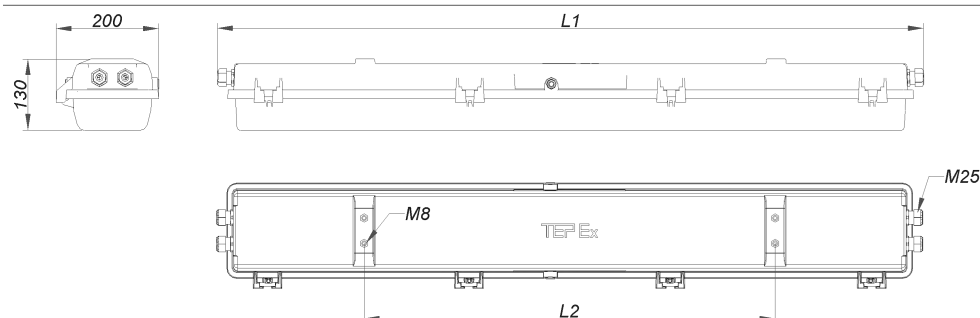

	L1 [mm]	L2 [mm]
PSF 218 E	750	400
PSF 236 E	1370	800

SPARE PARTS AND ACCESSORIES

Sketch	Description	Code	Sketch	Description	Code
	Diffuser PSF	PSF218 10-120 PSF236 20-120		Battery module	BATEx 01/6 BATEx 01/10
	Gasket PSF	PSF218 10-130 PSF236 20-130		Metal cable gland for arm cable	PSF 30-160
	Internal reflector with lamp holder PSF	PSF218 10-140 PSF236 20-140		PSF Ceiling mounting set	PSF 30-110
	El. ballast SMP	SMP 07/12 SMP 08 (PSF 258)		PSF Pipe mounting set	PSF 30-120
	Terminals 5x2,5mm ²	PSF236 20-150		PSF Wall mounting set	PSF 30-130
	Electronic ballast emergency module	SMPE 15-1 SMPE 15-2		Ring bolt M8	PSF 30-140

All technical data is relevant at the time of print.

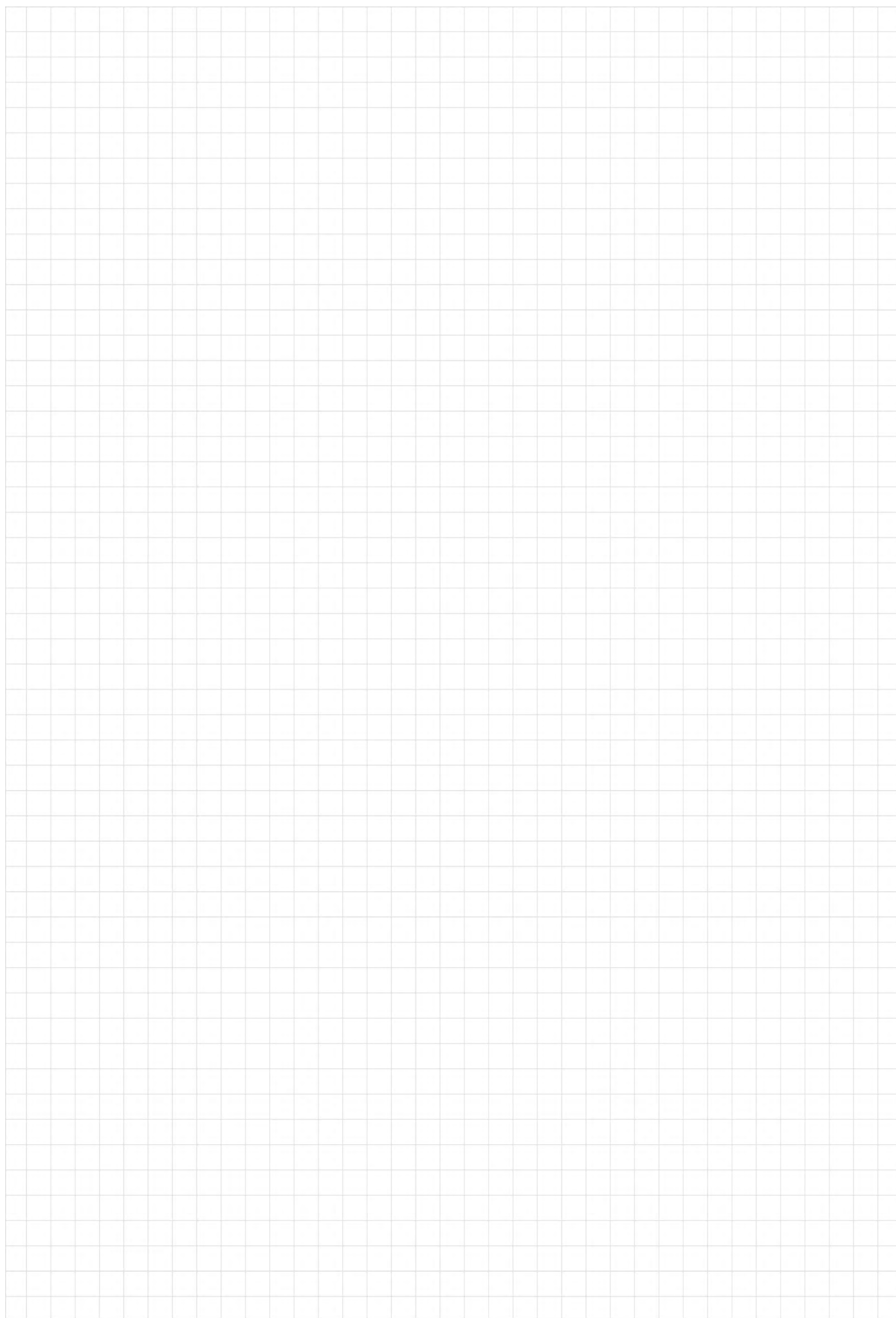

Installation equipment



IP 66



- Enclosure made of glass-fibre reinforced polyester resin
- 2 pole OFF switch or changeover switch



CONSTRUCTION

Enclosure: polyester plastic reinforced with glass fiber, color - black
Cover: with integrated thermoplastic elastomer gasket, closes with four M5 stainless steel screws.

TECHNICAL DATA

Certificate:	FIDI 19 ATEX 0022X
Marking:	0722
Apparatus category:	II 2G
Marking of explosion protection:	Ex d e IIC T6 Gb
Ambient temperature ATEX:	$-20^{\circ}\text{C} \leq T_a \leq +40/+50^{\circ}\text{C}$
Degree of protection:	IP 66 category 1
Resistance to shock:	IK 08
Protection class :	I (protective earthing)
Rated isolating voltage:	690 V
Thermal current I_{the} :	16 A for $-20^{\circ}\text{C} \leq T_a \leq +40^{\circ}\text{C}$ 15 A for $-20^{\circ}\text{C} \leq T_a \leq +50^{\circ}\text{C}$
PE terminals (inside of the enclosure):	max. 2x4 mm ² +2x2,5 mm ² , 3x4 mm ² , 2x6 mm ²
Weight:	App. 0,6kg

Installation switch

MODEL CODE

Installation switches SKX - SW / .

basic type code

type of switches

2 - on-off switch 2 pole

6 - changeover switch

Switching capacity	Rated operating voltage Ue	Rated operating current Ie
AC 5a	230 V	16 A for $-20^{\circ}\text{C} \leq T_a \leq +40^{\circ}\text{C}$ 15 A for $-20^{\circ}\text{C} \leq T_a \leq +50^{\circ}\text{C}$
AC 5b	230 V	16 A for $-20^{\circ}\text{C} \leq T_a \leq +40^{\circ}\text{C}$ 15 A for $-20^{\circ}\text{C} \leq T_a \leq +50^{\circ}\text{C}$
AC 1	500 V	16 A for $-20^{\circ}\text{C} \leq T_a \leq +40^{\circ}\text{C}$ 15 A for $-20^{\circ}\text{C} \leq T_a \leq +50^{\circ}\text{C}$
AC 15	250 V 500 V	6 A for $-20^{\circ}\text{C} \leq T_a \leq +50^{\circ}\text{C}$ 4 A for $-20^{\circ}\text{C} \leq T_a \leq +50^{\circ}\text{C}$
DC 13	24 V 60 V 110 V	6 A for $-20^{\circ}\text{C} \leq T_a \leq +50^{\circ}\text{C}$ 0,8 A for $-20^{\circ}\text{C} \leq T_a \leq +50^{\circ}\text{C}$ 0,5 A for $-20^{\circ}\text{C} \leq T_a \leq +50^{\circ}\text{C}$

WIRING DIAGRAM

ON-OFF switch 2 pole

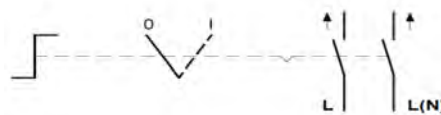

Changeover switch

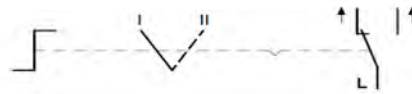

DIMENSION

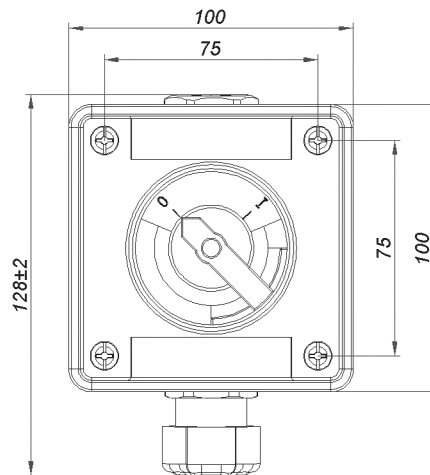
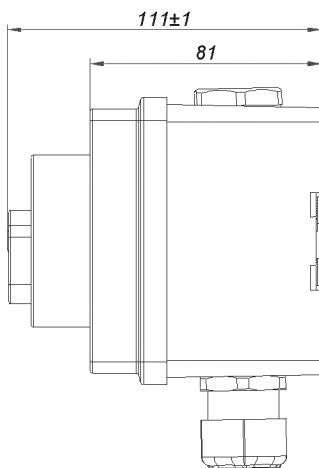

MOUNTING

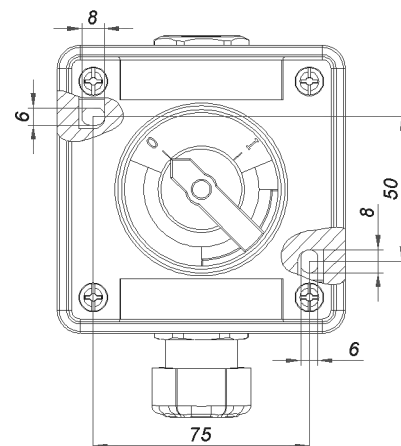

All technical data is relevant at the time of print.

IP 66



CONSTRUCTION

Enclosure: PA glass fiber reinforced polyamide, color - black

Cover: PA glass fiber reinforced polyamide with integrated thermoplastic elastomer gasket, closes with four M5 stainless steel screws.

TECHNICAL DATA

Certificate:	FIDI 19 ATEX 0002X RU C-HR.AB24.B.03290		
Marking:	0722		
Apparatus category:	II 2G II 2D		
Marking of explosion protection:	Ex eb IIC T6 Gb Ex ia/ib IIC T6 Gb Ex tb IIIC T80°C Db		
Ambient temperature ATEX:	-20°C < T _a < +40°C -20°C < T _a < +50°C -20°C < T _a < +55°C -20°C < T _a < +70°C, for Ex i T _a > -40°C – on request with specially designed cable glands		
EAC:	-50°C ≤ T _a ≤ +50°C		
Degree of protection:	IP 66 category 1		
Resistance to shock:	IK 08		
Protection class :	I (protective earthing)		
Rated voltage:	630 V		
Maximum voltage for Ex i:	60 V		
Maximum current of terminals :	22 A	T _a ≤ 40°C	RK 01/744,
	18 A	T _a ≤ 50°C	RK 01/544
	14 A	T _a ≤ 55°C	RK 01/544-E
	20 A	T _a ≤ 40°C	RK 01/514
	16 A	T _a ≤ 50°C	RK 01/514-2
	13 A	T _a ≤ 55°C	
	25 A	T _a ≤ 40°C	RK 01/516
	20 A	T _a ≤ 50°C	
	16 A	T _a ≤ 55°C	
PE terminals (inside of the enclosure):	max. 2x4 mm ² +2x2,5 mm ² , 3x4 mm ² , 2x6 mm ²		
Weight:	0,55 kg		
Packing:	The packing contains: 14 pcs 435x260x220 mm		

MOUNTING

With two screws through the housing holes φ6 mm at the peaks the rectangle: 100 x 75 mm

- Enclosures made of PA glass fiber reinforced polyamide
- The cover screws and all other external metal parts are made of stainless steel (AISI 316L)
- Equipped with terminals up to 6mm²
- Pillar (mantle) terminals

Junction box

MODEL CODE

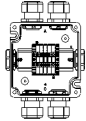
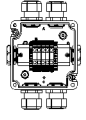
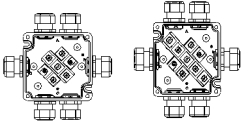
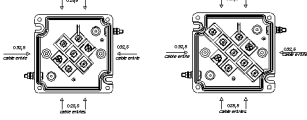
TYPE	VERSION	CABLE GLANDS AND PLUGS / CABLE ENTRIES	NUMBER OF TERMINALS AND TERMINAL CROSS SECTION	MAX. POSSIBLE CONNECTION BY TERMINAL solid, stranded, flexible
RK 01/514		4 x M25 cable glands for cables \varnothing_v 7-15 mm 2 x M25 plug	5 - 1 x 4mm ²	1x0,5...4mm ² 2x0,5...2,5mm ²
RK 01/514 Exi				
RK 01/516			5 - 1 x 6mm ²	1x1,5...6mm ² 2x1,5...4mm ²
RK 01/544		6 x M25 cable glands for cables \varnothing_v 7-15mm	5 - 4 x 4mm ²	4x4mm ² 6x2,5mm ² 1x4mm ² + 2x2,5mm ² + +3x1,5mm ²
RK 01/744			7 - 4 x 4mm ²	1x4mm ² + 5x1,5mm ² 2x4mm ² + 3x2,5mm ²
RK 01/544-E		2 x \varnothing 32,5mm 4 x \varnothing 25,5mm	5 - 4 x 4mm ²	4x4mm ² 6x2,5mm ² 1x4mm ² + 2x2,5mm ² + +3x1,5mm ²
RK 01/744-E			7 - 4 x 4mm ²	1x4mm ² + 5x1,5mm ² 2x4mm ² + 3x2,5mm ²

Other configuration available on request

DIMENSION

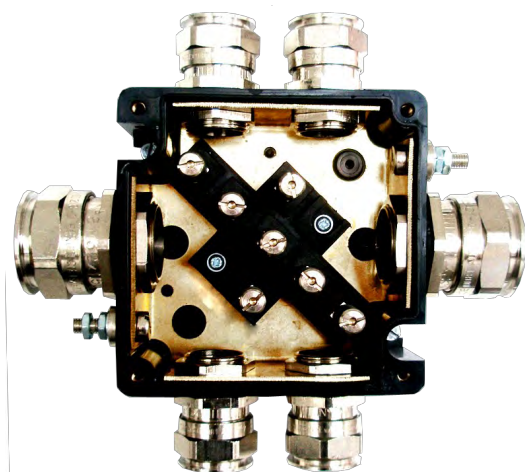
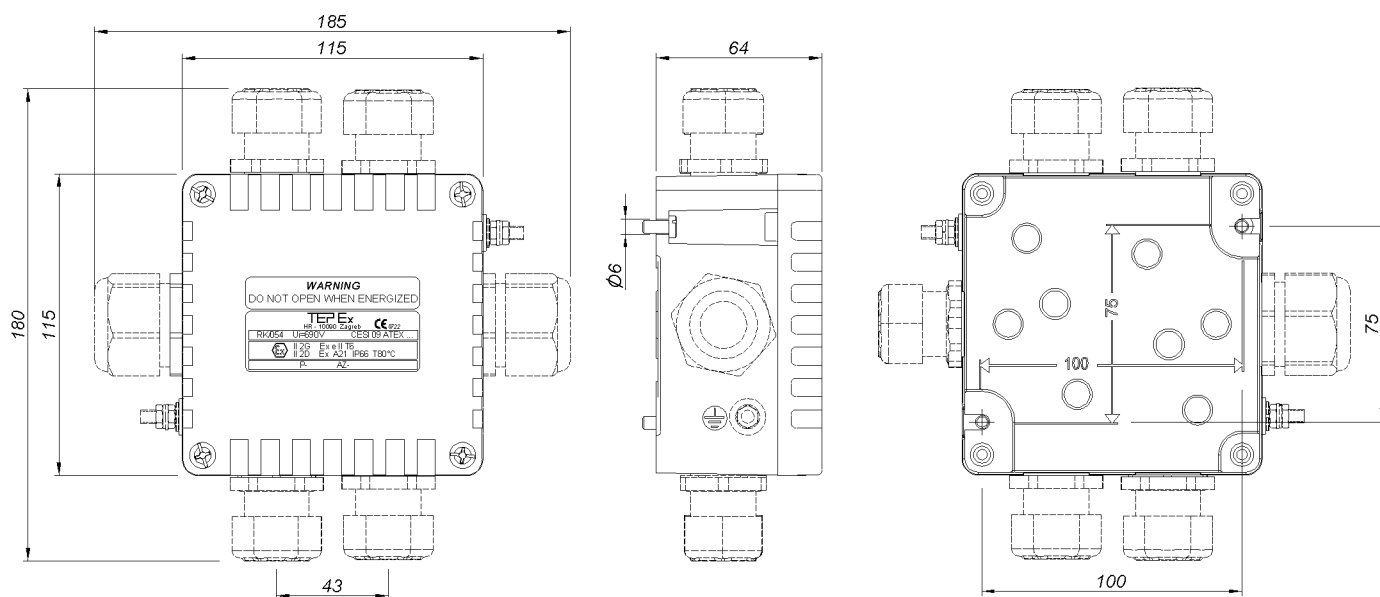

RK 01/744-E (internal metal plate)



All technical data is relevant at the time of print.



IP 66



- Ex d enclosure made of saltwater-resistant, copper-free aluminium cast alloy
- In terminal box versions standard cable glands without compound can be used

JBX 04



CONSTRUCTION

Enclosure: corrosion resistant grey polyurethanes painted aluminium color RAL 7000
Gasket: Silicon

TECHNICAL DATA

Certificate:	FIDI 19 ATEX 0033 , IECEx EXA 16.0002U
Marking:	0722
Apparatus category:	II 2G II 2D
Marking of explosion protection:	Ex db IIC T6 Gb Ex tb IIIC T80°C Db
Ambient temperature:	$-40^{\circ}\text{C} \leq T_a \leq +50^{\circ}\text{C}$
Degree of protection:	IP 66 category 1
Rated voltage:	630V
Resistance to shock:	IK 08
Protection class :	I (protective earthing)
Max. current for nominal croesection:	1,5 mm ² - 10A 2,5 mm ² - 16A 4 mm ² - 20A
External earthing terminal:	max. 2 x 6 mm ²
Weight:	0,95 kg

MOUNTING

With two screws M6 x 20mm on distance 123 mm

MODEL CODE

TYPE	No. of entries/side	Entries
JBX 04/21	2 / A-C	M20x1,5
JBX 04/31	3 / B-C-D	
JBX 04/41	4 / A-B-C-D	
JBX 04/22	2 / A-C	1/2" NPT
JBX 04/32	3 / B-C-D	
JBX 04/42	4 / A-B-C-D	

DIMENSION

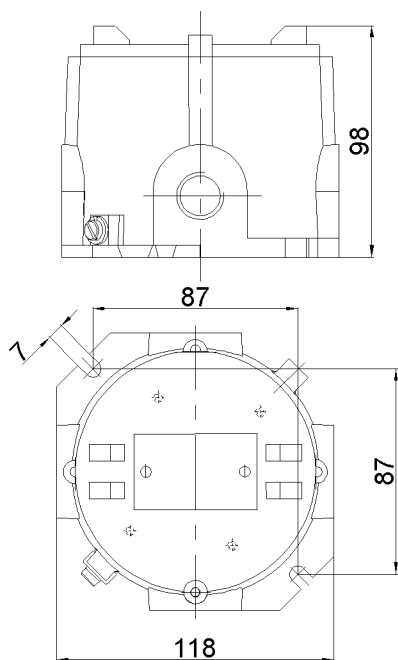

IP 66



SKX .. /E



- Enclosures in shock-resistant glass fiber reinforced polyester resin
- 7 basic enclosure sizes
- Fitted according to the customer's requirements

CONSTRUCTION

Enclosure: SMC glass fiber reinforced polyamide, color - black
 Cover: SMC glass fiber reinforced polyamide with integrated thermoplastic elastomer gasket, closes with four M5/M6 stainless steel screws.

TECHNICAL DATA

Certificate:	FIDI 19 ATEX 0056 , FIDI 19 ATEX 0057 EAC RU C-HR.AB24.B.03292
Marking:	0722
Apparatus category:	II 2G II 2D
Marking of explosion protection:	II 2G Ex eb IIC T6 Gb II 2G Ex ia/ib IIC T6 Gb II 2G Ex eb ia/ib IIC T6 Gb II 2D Ex tb IIC T80° Db
Ambient temperature ATEX: EAC:	-20°C ≤ T _a ≤ +40°C/+50°C/+55°C -50°C ≤ T _a ≤ +50°C
Degree of protection:	IP 66 category 1
Resistance to shock:	IK 08
Protection class :	I (protective earthing)
Rated voltage:	630 V
Nominal current:	Up to 125 A (depend on size and number of terminals)
Maximum safe voltage U_m for intrinsically safe circuits Exi:	60 V
PE terminals (inside of the enclosure):	max. 2x4 mm ² +2x2,5 mm ² , 3x4 mm ² , 2x6 mm ²
N/PE rails inside the enclosure:	2 pcs, 11 terminals 2x4mm ² max.
Weight (without cable glands):	SKX 12/E 0,5kg SKX 13/E 0,7kg SKX 14/E 1,0kg SKX 15/E 1,0 - 1,5kg SKX 17/E 3,8kg SKX 18/E 4,5kg SKX 20/E 7,0kg

MOUNTING

With two/four screws through the housing holes $\phi 6$ mm at the peaks the rectangle:

SKX 12: 75 x 50 mm	SKX 17: 285 x 200 mm
SKX 13: 75 x 100 mm	SKX 18: 380 x 200 mm
SKX 14: 75 x 150 mm	SKX 20: 580 x 200 mm
SKX 15: 125 x 150 mm	

Terminal box SKX 12/E

Nominal cross-section of conductor / terminal [mm ²]	Max. number of terminals	Max.ambient temp Ta °C	I _{max} [A]
4/4	5	40	20
		50	18
		55	17

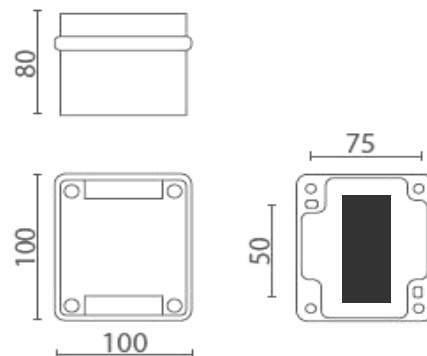

Max. number of cable entries:

Cable gland Side	M16	M20	M25
A-C	2	2	1
B-D	1	1	1

Terminal box SKX 13/E

Nominal cross-section of conductor / terminal [mm ²]	Max. number of terminals	Max.ambient temp Ta °C	I _{max} [A]
4/4	8	40	19
		50	17
		55	16
6/6	8	40	25
		50	22
		55	19

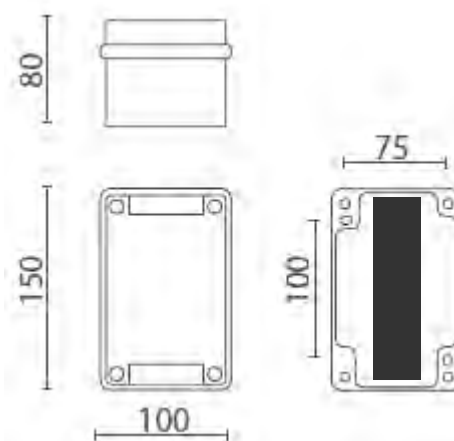

Max. number of cable entries:

Cable gland Side	M16	M20	M25
A-C	2	2	1
B-D	4	3	2

Terminal box SKX 14/E

Nominal cross-section of conductor / terminal [mm ²]	Max. number of terminals	Max.ambient temp Ta °C	I _{max} [A]
4/4	16	40	20
		50	18
		55	16
6/6	16	40	25
		50	22
		55	19

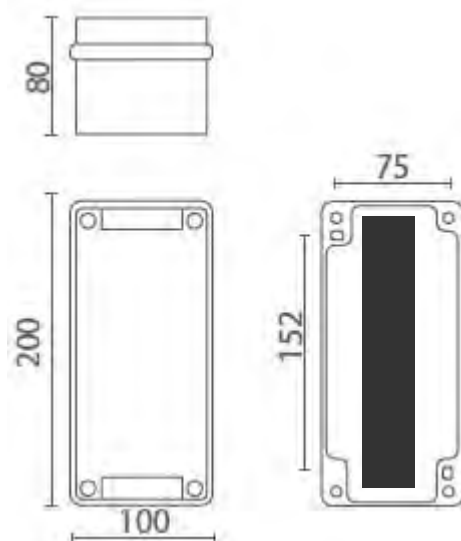

Max. number of cable entries:

Cable gland Side	M16	M20	M25	M32
A-C	2	2	1	1
B-D	6	4	3	2

Terminal box SKX 15/E

Table of permitted combinations of conductors on the principle of maximum rated losses (ambient temperature Ta 40°C)

Nominal cross-section of conductor / terminal [mm ²]	Maximum number of terminals	I _{max} [A]
2,5/2,5	28	12
4/4	24	16
6/6	16	20
10/10	12	33
16/16	12	50
25/25	8	60
35/35	4	80

The maximum number of terminals specified by the measures of the terminal boxes	24 + busbar 22PE	24	16	14	12	8	4
Width of terminal [mm]	5	6	7	10	12	12	15
Allowed number of conductors per terminal	1x2.5-1.5 mm ²	1 x4-1.5 mm ²	1 x6-1.5 mm ²	1 x10-2.5 mm ²	1 x16-2.5 mm ²	1 x 25-6 mm ²	1 x 35-6 mm ²
Width of PE terminal [mm]	6	6	8	10	12	16	16
Width of final terminal [mm]	9						
Space for a terminal on DIN rail without end terminals	max. 140 mm						

- 1) Two conductors are connected on one terminal
- 2) PE conductors and jumpers are not taken in the calculation

It is possible to connect on one terminal smaller nominal cross-section conductors, but the maximum number of conductors and maximum current for the nominal wire size must be respected according to "Table of permitted installation".

Combination of many different nominal cross-section terminals and conductors in one terminal box is allowed. Possible combinations are calculated on the basis of the "Table of permitted installation" so that the total maximum losses and the possibility of a physical installation is possible.

Terminal box

Max. number of cable entries:

DIMENSIONS [mm]

Side	Cable gland	M16	M20	M25	M32
A-C		4	3	2	2
B-D		6	4	3	2

Side	Cable gland	M16	M20	M25	M32
A-C		4	3	2	2
B-D		5	3	3	-

*with N/PE rails

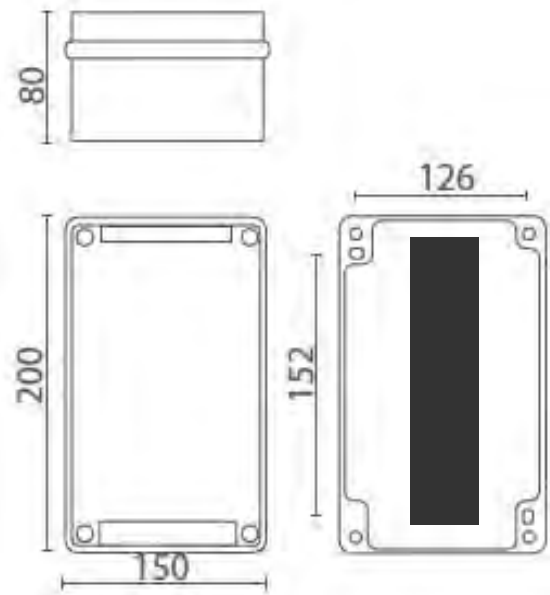

Terminal box SKX 17/E

Table of allowed number of terminals

Nominal cross section of conductors / terminals (mm ²)	Maximum number of terminals	Ambient temperature Ta[°C]	I _{max} [A]
2,5 / 2,5	70	-20°C ÷ +40 °C	9
2,5 / 2,5	36		13
2,5 / 2,5	4		18
2,5 / 2,5	70	-20°C ÷ +50 °C	8
2,5 / 2,5	36		11
2,5 / 2,5	4		16
4 / 4	61	-20°C ÷ +40 °C	13
4 / 4	30		18
4 / 4	4		26
4 / 4	61	-20°C ÷ +50 °C	11
4 / 4	30		16
4 / 4	4		22
6 / 6	40	-20°C ÷ +40 °C	18
6 / 6	22		26
6 / 6	4		35
6 / 6	40	-20°C ÷ +50 °C	16
6 / 6	22		22
6 / 6	4		31
10 / 10	37	-20°C ÷ +40 °C	26
10 / 10	17		40
10 / 10	4		48
10 / 10	37	-20°C ÷ +50 °C	22
10 / 10	17		34
10 / 10	4		40
16 / 16	27	-20°C ÷ +40 °C	38
16 / 16	15		52
16 / 16	4		65
16 / 16	27	-20°C ÷ +50 °C	32
16 / 16	15		45
16 / 16	4		56
25 / 25	24	-20°C ÷ +40 °C	52
25 / 25	15		65
25 / 25	4		86
25 / 25	24	-20°C ÷ +50 °C	45
25 / 25	15		56
25 / 25	4		74
35 / 35	16	-20°C ÷ +40 °C	65
35 / 35	10		90
35 / 35	4		105
35 / 35	16	-20°C ÷ +50 °C	56
35 / 35	10		80
35 / 35	4		90
50 / 50	14	-20°C ÷ +40 °C	90
50 / 50	4		120
50 / 50	11	-20°C ÷ +50 °C	80
50 / 50	4		105

Terminal box

Max. number of cable entries:

DIMENSIONS [mm]

Side	Cable gland	M20	M25	M32	M40	M50	M63
B-D		9	9	5	3	3	2
A-C		7	5	3	3	1	1

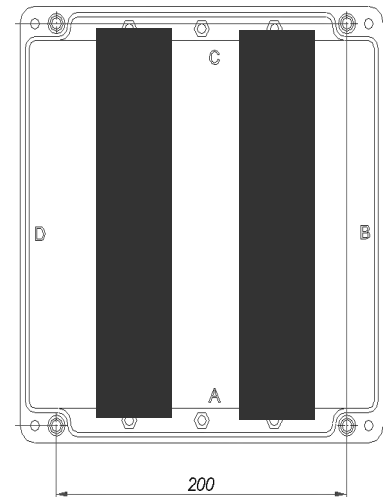
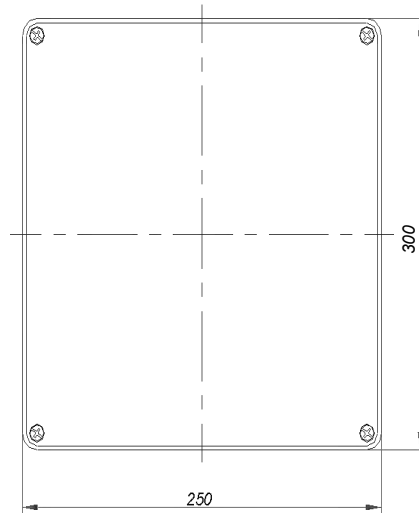
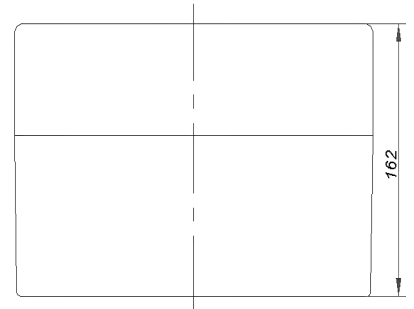
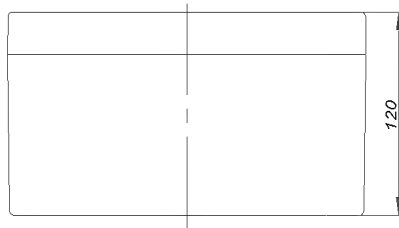

Terminal box SKX 18/E

Table of allowed number of terminals

Nominal cross section of conductors / terminals (mm ²)	Maximum number of terminals	Ambient temperature Ta[°C]	I _{max} [A]
2,5 / 2,5	180	-20°C ÷ +40 °C	9
2,5 / 2,5	64		12
2,5 / 2,5	4		16
2,5 / 2,5	108	-20°C ÷ +50 °C	8
2,5 / 2,5	64		10
2,5 / 2,5	4		14
4 / 4	103	-20°C ÷ +40 °C	12
4 / 4	54		16
4 / 4	4		23
4 / 4	103	-20°C ÷ +50 °C	10
4 / 4	54		14
4 / 4	4		20
6 / 6	83	-20°C ÷ +40 °C	16
6 / 6	40		23
6 / 6	4		34
6 / 6	83	-20°C ÷ +50 °C	14
6 / 6	40		20
6 / 6	4		30
10 / 10	68	-20°C ÷ +40 °C	23
10 / 10	32		34
10 / 10	4		48
10 / 10	68	-20°C ÷ +50 °C	20
10 / 10	32		30
10 / 10	4		42
16 / 16	48	-20°C ÷ +40 °C	34
16 / 16	26		48
16 / 16	4		60
16 / 16	48	-20°C ÷ +50 °C	30
16 / 16	26		42
16 / 16	4		50
25 / 25	40	-20°C ÷ +40 °C	48
25 / 25	26		60
25 / 25	4		80
25 / 25	40	-20°C ÷ +50 °C	42
25 / 25	26		50
25 / 25	4		70
35 / 35	36	-20°C ÷ +40 °C	60
35 / 35	20		80
35 / 35	4		105
35 / 35	36	-20°C ÷ +50 °C	50
35 / 35	20		70
35 / 35	4		90
50 / 50	26	-20°C ÷ +40 °C	80
50 / 50	16		110
50 / 50	4		125
50 / 50	26	-20°C ÷ +50 °C	70
50 / 50	16		95
50 / 50	4		100

Terminal box

Max. number of cable entries:

DIMENSIONS [mm]

Side	Cable gland	M20	M25	M32	M40	M50	M63
B-D		17	15	9	6	5	4
A-C		9	7	3	3	2	2

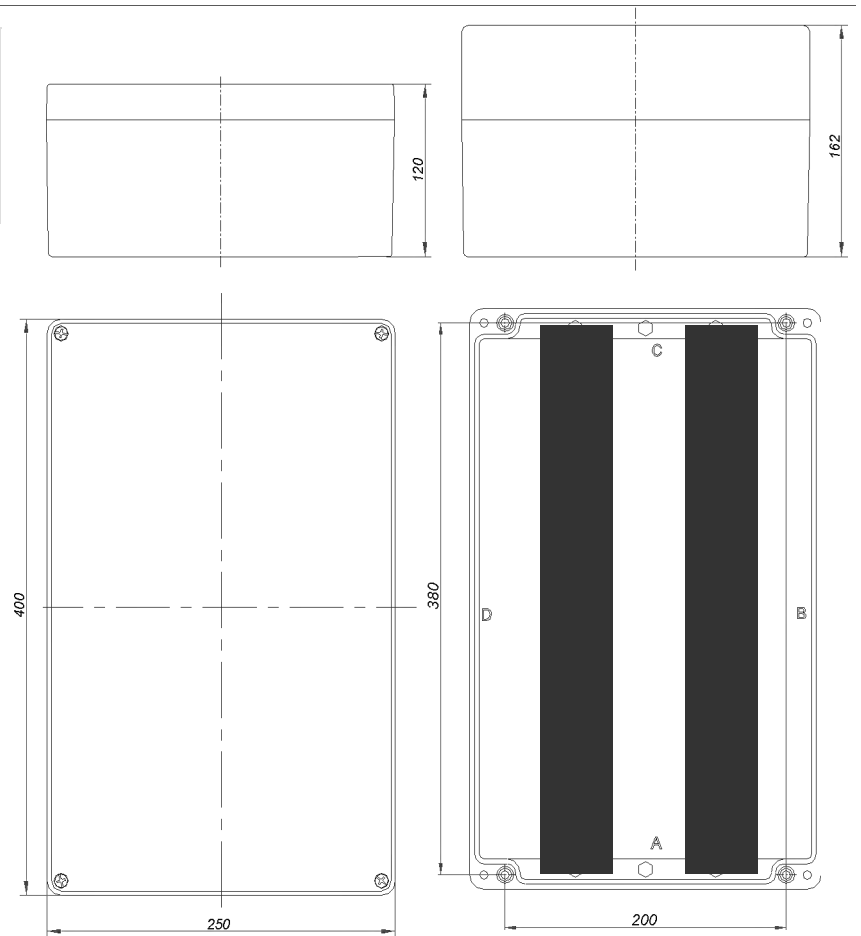

Terminal box SKX 20/E

Table of allowed number of terminals

Nominal cross section of conductors / terminals (mm ²)	Maximum number of terminals	Ambient temperature Ta[°C]	I _{max} [A]
2,5 / 2,5	200	-20°C ÷ +40 °C	6
2,5 / 2,5	126		9
2,5 / 2,5	78		12
2,5 / 2,5	4		16
2,5 / 2,5	126	-20°C ÷ +50 °C	8
2,5 / 2,5	78		10
2,5 / 2,5	4		14
4 / 4	180		9
4 / 4	122	-20°C ÷ +40 °C	12
4 / 4	66		16
4 / 4	4		23
4 / 4	122		10
4 / 4	66	-20°C ÷ +50 °C	14
4 / 4	4		20
6 / 6	98		16
6 / 6	48		23
6 / 6	4	-20°C ÷ +40 °C	34
6 / 6	98		14
6 / 6	48		20
6 / 6	4		30
10 / 10	80	-20°C ÷ +50 °C	23
10 / 10	36		34
10 / 10	4		48
10 / 10	80		20
10 / 10	36	-20°C ÷ +40 °C	30
10 / 10	4		42
16 / 16	58		34
16 / 16	29		48
16 / 16	4	-20°C ÷ +50 °C	60
16 / 16	58		30
16 / 16	29		42
16 / 16	4		50
25 / 25	46	-20°C ÷ +40 °C	48
25 / 25	30		60
25 / 25	4		80
25 / 25	46		42
25 / 25	30	-20°C ÷ +50 °C	50
25 / 25	4		70
35 / 35	41		60
35 / 35	23		80
35 / 35	4	-20°C ÷ +40 °C	105
35 / 35	41		50
35 / 35	23		70
35 / 35	4		90
50 / 50	33	-20°C ÷ +50 °C	80
50 / 50	18		110
50 / 50	4		125
50 / 50	33		70
50 / 50	18	-20°C ÷ +40 °C	95
50 / 50	4		100

Terminal box

Max. number of cable entries:

DIMENSIONS [mm]

Side	Cable gland	M20	M25	M32	M40	M50	M63
B-D		24	22	12	8	6	6
A-C		9	7	3	3	2	2

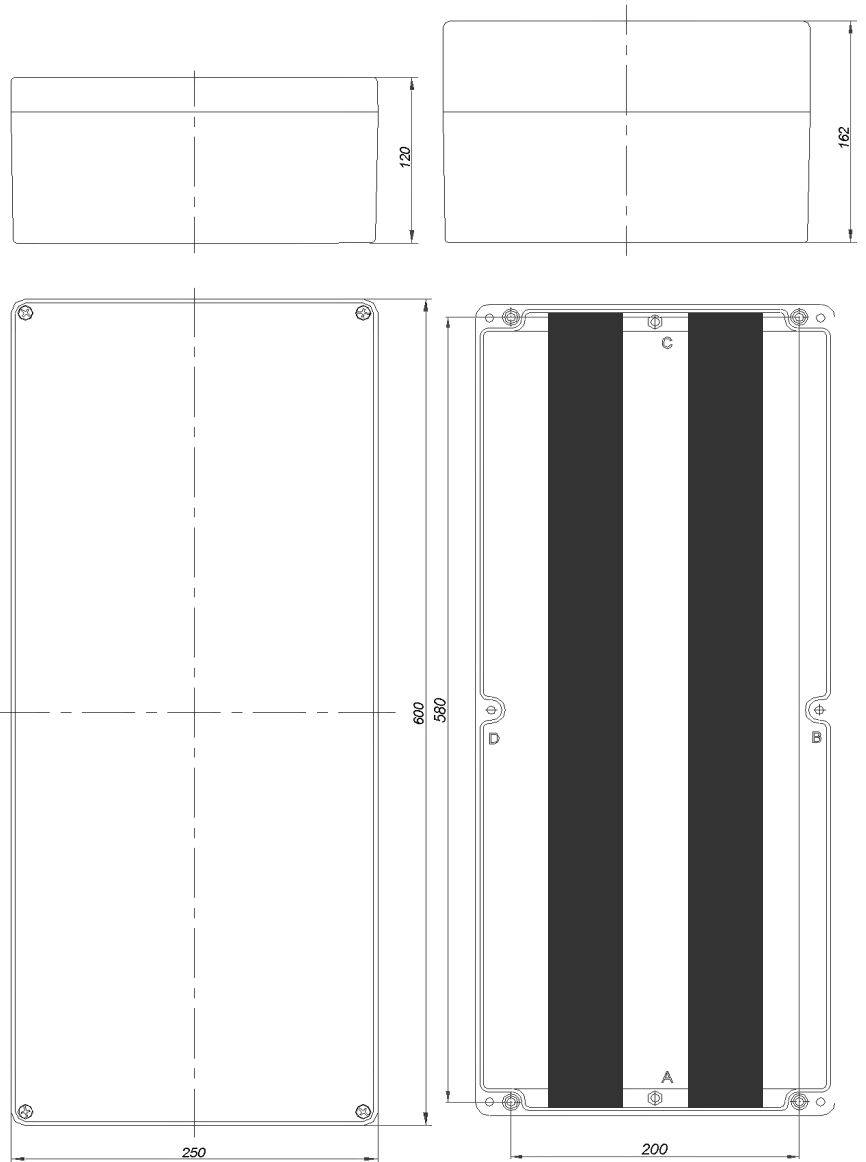

IP 66



SKX ..I/E



- Enclosures in stainless steel AISI 316L
- 4 basic enclosure sizes
- Fitted according to the customer's requirements

CONSTRUCTION

Enclosure: Stainless steel AISI 316L, brush finished, thickness 1.5mm
Cover: with integrated thermoplastic elastomer gasket, closes with four M5 stainless steel screws.

TECHNICAL DATA

Certificate:	FIDI 19 ATEX 0057 EAC RU C-HR.AB24.B.03296
Marking:	0722
Apparatus category:	II 2G II 2D
Marking of explosion protection:	Ex eb IIC TG Gb Ex ia/ib IIC TO Gb Ex eb ia/ib IIC T6 cb Ex tb IIIC T80°C Db
Ambient temperature ATEX: EAC:	-20°C ≤ T _a ≤ +50°C -50°C ≤ T _a ≤ +50°C
Degree of protection:	IP 66 category 1
Resistance to shock:	IK 08
Protection class :	I (protective earthing)
Rated voltage:	630 V
Nominal current:	Up to 125 A (depend on size and number of terminals)
Maximum safe voltage U_m for intrinsically safe circuits Exi:	60 V
PE terminals (inside of the enclosure):	max. 2x4 mm ² +2x2,5 mm ² , 3x4 mm ² , 2x6 mm ²
N/PE rails inside the enclosure:	2 pcs, 11 terminals 2x4mm ² max.
Weight (without cable glands):	SKX 16I/E 3,1 kg SKX 18I-1/E..... 4,8 kg SKX 18I-2/E 5,4 kg SKX 20I/E 5,6 kg

MOUNTING

With four screws through the housing holes $\phi 8$ mm at the peaks the rectangle:



Stainless steel terminal box SKX 16I/E, SKX 18I-1/E, SKX 18I-2/E, SKX 20 I

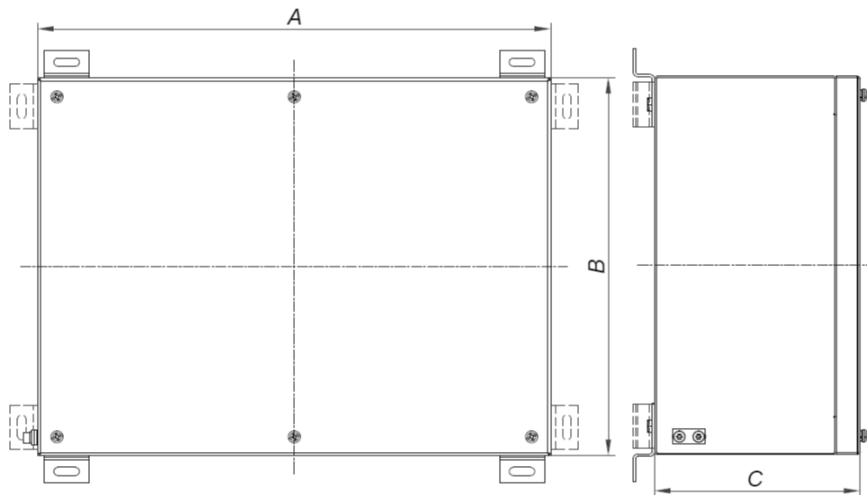

Type	A[mm]	B[mm]	C[mm]
SKX 16I/E	300	200	120
SKX 18I-1/E	400	200	120
SKX 18I-2/E	400	300	120
SKX 20I/E	600	200	120

MOUNTING

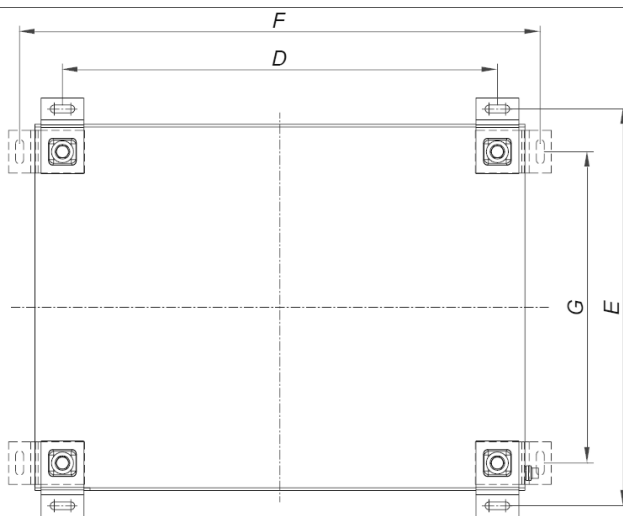

Type	D[mm]	E[mm]	F[mm]	G[mm]
SKX 16I/E	255	225	330	152
SKX 18I-1/E	355	225	430	152
SKX 18I-2/E	355	325	430	252
SKX 20I/E	555	625	630	152

Max. number of mounted cable entries:

TYPE Dimension	SKX 16I/E 300X200X120		SKX 18I-1/E 400X200X120		SKX 18I-2/E 400X300X120		SKX 20I/E 600X200X120	
	A-C	B-D	A-C	B-D	A-C	B-D	A-C	B-D
M20x1.5	9	10	9	17	9	17	9	24
M25x1.5	7	9	7	15	7	15	7	22
M32x1.5	3	5	3	9	3	9	3	12
M40x1.5	3	3	3	6	3	6	3	8
M50x1.5	2	3	2	5	2	5	2	6
M63x1.5	2	2	2	4	1	4	2	6

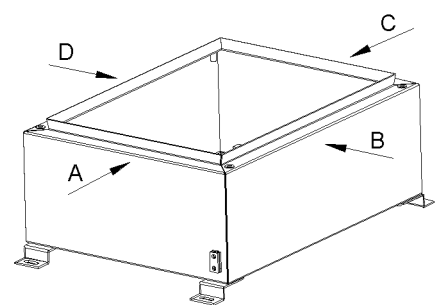

All technical data is relevant at the time of print.

Terminal box SKX 16I/E (300x200x120 mm)

Table of allowed number of terminals

Nominal cross section of conductors / terminals (mm ²)	Maximum number of terminals	Ambient temperature Ta[°C]	I _{max} [A]
2,5 / 2,5	60	-20°C ÷ +40 °C	9
2,5 / 2,5	30		13
2,5 / 2,5	4		18
2,5 / 2,5	60	-20°C ÷ +50 °C	8
2,5 / 2,5	30		11
2,5 / 2,5	4		16
4 / 4	48	-20°C ÷ +40 °C	13
4 / 4	24		18
4 / 4	4		26
4 / 4	48	-20°C ÷ +50 °C	11
4 / 4	24		16
4 / 4	4		22
6 / 6	36	-20°C ÷ +40 °C	18
6 / 6	18		26
6 / 6	4		35
6 / 6	36	-20°C ÷ +50 °C	16
6 / 6	18		22
6 / 6	4		31
10 / 10	30	-20°C ÷ +40 °C	26
10 / 10	14		40
10 / 10	4		48
10 / 10	30	-20°C ÷ +50 °C	22
10 / 10	14		34
10 / 10	4		40
16 / 16	22	-20°C ÷ +40 °C	38
16 / 16	11		52
16 / 16	4		63
16 / 16	22	-20°C ÷ +50 °C	32
16 / 16	11		45
16 / 16	4		54
25 / 25	18	-20°C ÷ +40 °C	52
25 / 25	11		65
25 / 25	4		80
25 / 25	18	-20°C ÷ +50 °C	45
25 / 25	11		56
25 / 25	4		69
35 / 35	14	-20°C ÷ +40 °C	65
35 / 35	8		90
35 / 35	4		94
35 / 35	14	-20°C ÷ +50 °C	56
35 / 35	8		80
35 / 35	4		82
50 / 50	10	-20°C ÷ +40 °C	90
50 / 50	3		12
50 / 50	10		80
50 / 50	3	-20°C ÷ +50 °C	105

Maximum possible number of terminals definite by enclosure dimensions

Maximum possible number of terminals definite by enclosure dimensions	36	30	22	18	15	15	10	8
Width of single terminal [mm]	5	6	7	10	12	12	15	18,5
Allowed cross-section of conductor for single terminal	1x2.5-1.5 mm ²	1 x4-1,5 mm ²	1 x6-1,5 mm ²	1 x10-2.5 mm ²	1 x16-2.5 mm ²	1 x 25-6 mm ²	1 x 35-6 mm ²	1 x 50-10 mm ²
Width of PE terminal [mm]	5	6	7	10	12	12	15	18.5
Width of end holder	9							
Space for terminals on DIN rail without end holders	max. 214 mm							

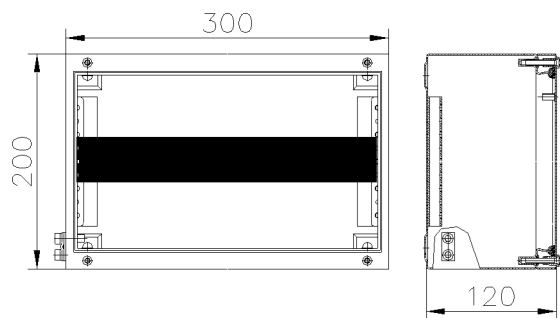

Terminal box **SKX 18I-1/E** (400x200x120 mm), **SKX 18I-2/E** (400x300x120 mm)

Table of allowed number of terminals

Nominal cross section of conductors / terminals (mm ²)	Maximum number of terminals	Ambient temperature Ta[°C]	I _{max} [A]
2,5 / 2,5	95	-20°C ÷ +40 °C	9
2,5 / 2,5	55		12
2,5 / 2,5	4		16
2,5 / 2,5	95	-20°C ÷ +50 °C	8
2,5 / 2,5	55		10
2,5 / 2,5	4		14
4 / 4	88	-20°C ÷ +40 °C	12
4 / 4	50		16
4 / 4	4		23
4 / 4	88	-20°C ÷ +50 °C	10
4 / 4	50		14
4 / 4	4		20
6 / 6	75	-20°C ÷ +40 °C	16
6 / 6	36		23
6 / 6	4		34
6 / 6	75	-20°C ÷ +50 °C	14
6 / 6	36		20
6 / 6	4		30
10 / 10	60	-20°C ÷ +40 °C	23
10 / 10	27		34
10 / 10	4		48
10 / 10	60	-20°C ÷ +50 °C	20
10 / 10	27		30
10 / 10	4		42
16 / 16	44	-20°C ÷ +40 °C	34
16 / 16	22		48
16 / 16	4		60
16 / 16	44	-20°C ÷ +50 °C	30
16 / 16	22		42
16 / 16	4		50
25 / 25	34	-20°C ÷ +40 °C	48
25 / 25	21		60
25 / 25	4		80
25 / 25	34	-20°C ÷ +50 °C	42
25 / 25	21		50
25 / 25	4		70
35 / 35	31	-20°C ÷ +40 °C	60
35 / 35	17		80
35 / 35	4		105
35 / 35	31	-20°C ÷ +50 °C	50
35 / 35	17		70
35 / 35	4		90
50 / 50	25	-20°C ÷ +40 °C	80
50 / 50	13		110
50 / 50	4		125
50 / 50	25	-20°C ÷ +40 °C	70
50 / 50	13		95
50 / 50	4		100

Maximum possible number of terminals definite by enclosure dimensions

Maximum possible number of terminals definite by enclosure dimensions	64	54	40	32	26	26	20	16
Width of single terminal [mm]	5	6	7	10	12	12	15	18,5
Allowed cross-section of conductor for single terminal	1x2.5-1.5 mm ²	1 x4-1.5 mm ²	1 x6-1.5 mm ²	1 x10-2.5 mm ²	1 x16-2.5 mm ²	1 x 25-6 mm ²	1 x 35-6 mm ²	1 x 50-10 mm ²
Width of PE terminal [mm]	5	6	7	10	12	12	15	18.5
Width of end holder	9							
Space for terminals on DIN rail without end holders	max. 300 mm							

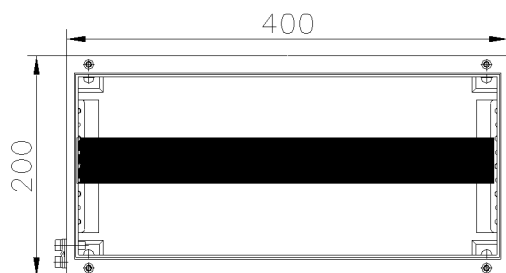

Ex terminal box SKX 18I-1/E

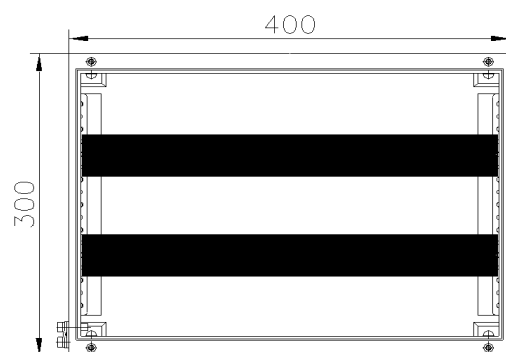
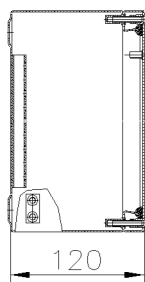

Ex terminal box SKX 18I-2/E

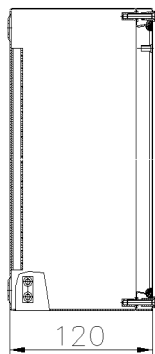

Terminal box SKX 20I/E (600x200x120 mm)

Table of allowed number of terminals

Nominal cross section of conductors / terminals (mm ²)	Maximum number of terminals	Ambient temperature Ta[°C]	I _{max} [A]
2,5 / 2,5	200	-20°C ÷ +40 °C	6
2,5 / 2,5	102		9
2,5 / 2,5	60		12
2,5 / 2,5	4		16
2,5 / 2,5	102	-20°C ÷ +40 °C	8
2,5 / 2,5	60		10
2,5 / 2,5	4		14
4 / 4	180	-20°C ÷ +50 °C	9
4 / 4	96		12
4 / 4	53		16
4 / 4	4	-20°C ÷ +40 °C	23
4 / 4	96		10
4 / 4	53		14
4 / 4	4		20
6 / 6	80	-20°C ÷ +50 °C	16
6 / 6	38		23
6 / 6	4		34
6 / 6	80	-20°C ÷ +40 °C	14
6 / 6	38		20
6 / 6	4		30
6 / 6	4		23
10 / 10	65	-20°C ÷ +50 °C	23
10 / 10	29		34
10 / 10	4		48
10 / 10	65	-20°C ÷ +40 °C	20
10 / 10	29		30
10 / 10	4		42
10 / 10	4		20
16 / 16	47	-20°C ÷ +50 °C	34
16 / 16	24		48
16 / 16	4		60
16 / 16	47	-20°C ÷ +40 °C	30
16 / 16	24		42
16 / 16	4		50
16 / 16	4		48
25 / 25	37	-20°C ÷ +50 °C	48
25 / 25	23		60
25 / 25	4		80
25 / 25	37	-20°C ÷ +40 °C	42
25 / 25	23		50
25 / 25	4		70
25 / 25	4		60
35 / 35	33	-20°C ÷ +50 °C	60
35 / 35	18		80
35 / 35	4		105
35 / 35	33	-20°C ÷ +40 °C	50
35 / 35	15		70
35 / 35	4		90
35 / 35	4		80
50 / 50	26	-20°C ÷ +50 °C	80
50 / 50	14		110
50 / 50	4		125
50 / 50	26	-20°C ÷ +40 °C	70
50 / 50	14		95
50 / 50	4		100

Maximum possible number of terminals definite by enclosure dimensions

Maximum possible number of terminals definite by enclosure dimensions	100	86	66	50	40	40	30	26
Width of single terminal [mm]	5	6	7	10	12	12	15	18,5
Allowed cross-section of conductor for single terminal	1x2.5-1.5 mm ²	1 x4-1,5 mm ²	1 x6-1,5 mm ²	1 x10-2.5 mm ²	1 x16-2.5 mm ²	1 x 25-6 mm ²	1 x 35-6 mm ²	1 x 50-10 mm ²
Width of PE terminal [mm]	5	6	7	10	12	12	15	18,5
Width of end holder	9							
Space for terminals on DIN rail without end holders	max. 500 mm							

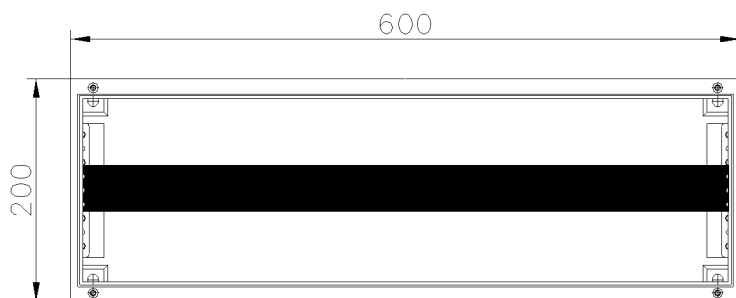

Ex terminal box SKX 20/E

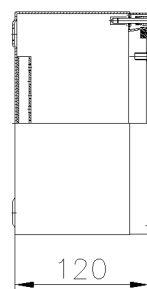

IP 66



SKX busbar AISI

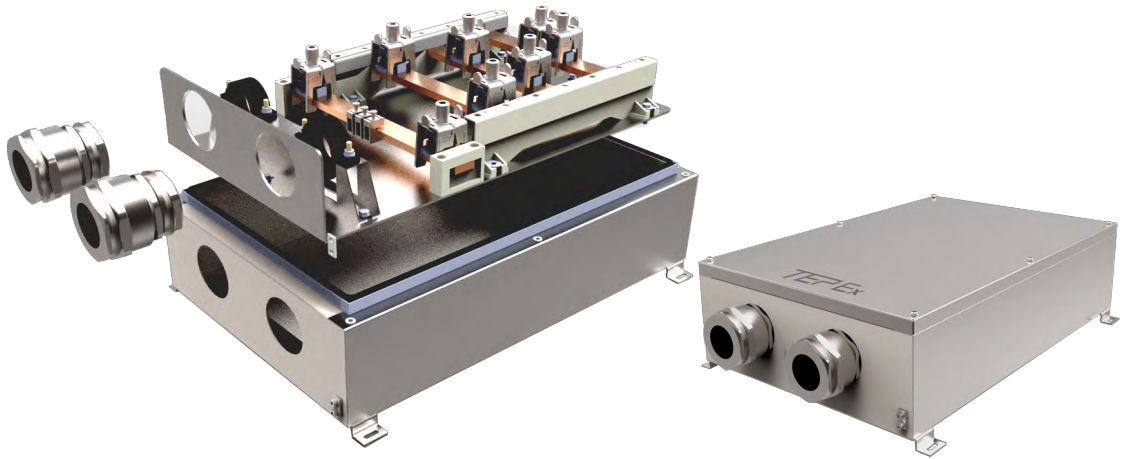

CONSTRUCTION

Enclosure: Stainless steel AISI 316L, 1.5mm
Gasket: EPDM formed gasket

TECHNICAL DATA

Certificate:	Ex FIDI 19 ATEX 0054, FIDI 19 ATEX 0055
Marking:	CE 0722
Apparatus category:	II 2G II 2D
Marking of explosion protection:	Ex eb IIC T6/T5 Gb Ex tb IIIC T80°C/T95°C Db
Ambient temperature ATEX:	-40°C ≤ T _a ≤ +50°C
Degree of protection:	IP 66 category 1
Resistance to shock:	IK 09
Protection class :	I (protective earthing)
Nominal voltage U_n:	690 V ±10%

Table of maximum currents:

Terminal	Cross section	t _{amb} -40°C do +40°C	t _{amb} -40°C do +50°C
300mm ²	240 mm ²	450 A	425 A
	185 mm ²	440 A	390 A
	150 mm ²	400 A	350 A
	120 mm ²	350 A	300 A
120 mm ²	95 mm ²	300 A	250 A
	70 mm ²	220 A	185 A
	50 mm ²	160 A	130 A
	35 mm ²	100 A	80 A

- For terminals from 50... 300 mm²
- Rated operational current up to max. 450 A depending on enclosure version and size
- SKX 1008020 (1000x800x200mm) with hinged door

Busbar enclosure

MODEL CODE

SKX xxxxxxxx- . / ...

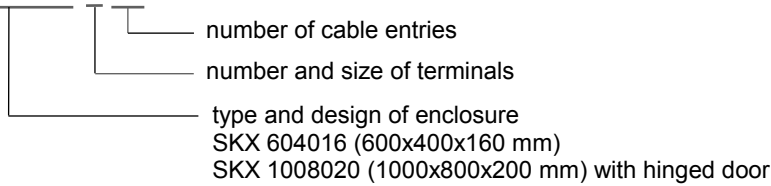

DIMENSION DRAWING (mm)

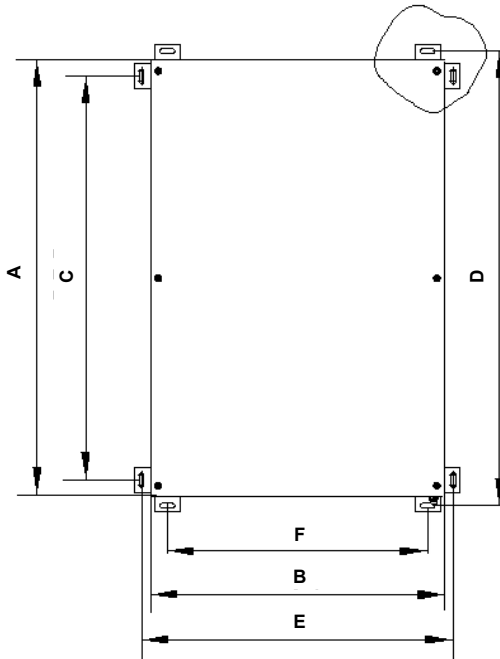

Type	A	B	C	D	E	F
SKX 604016	800	600	555	622	422	355
SKX 1008020	1000	800	800	-	850	-

SPARE PARTS AND ACCESSORIES

SKETCH	DESCRIPTION	CODE	SKETCH	DESCRIPTION	CODE
	Cover	SKX 604016/ 10-100		Terminal 35 mm ²	SKX 604016/ 10-170
	Gasket	SKX 604016/ 10-110		Terminal 120 mm ²	SKX 604016/ 10-180
	Cover screw M5x25	SKX 604016/ 10-120		Terminal 300 mm ²	SKX 604016/ 10-190
	Mounting set	SKX 604016/ 10-130		Strain relief set 3/4"	SKX 604016/ 10-200
	Busbar holder PE	SKX 604016/ 10-140		Strain relief set 1"	SKX 604016/ 10-210
	Busbar holder	SKX 604016/ 10-150		Strain relief set 5/4"	SKX 604016/ 10-220
	Busbar Cu 30x10	SKX 604016/ 10-160		Strain relief set 6/4"	SKX 604016/ 10-230

All technical data is relevant at the time of print.

SKX busbar GRP

IP 66

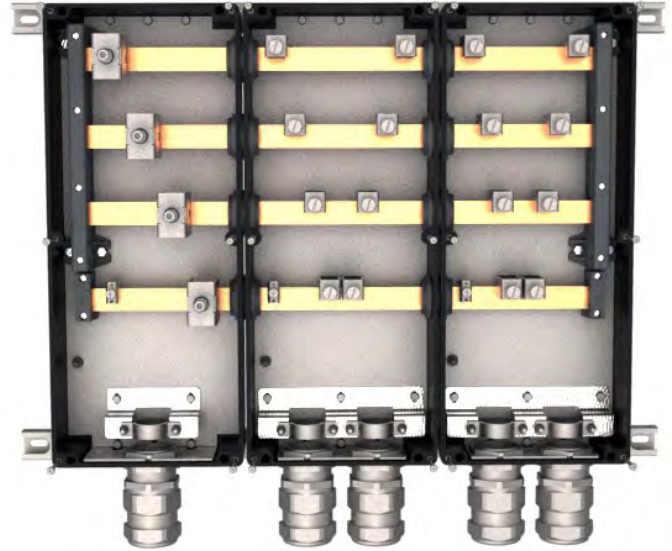

CONSTRUCTION

Enclosure: Stainless steel AISI 316L, 1.5mm
Gasket: EPDM formed gasket

TECHNICAL DATA

Certificate:	Ex FIDI 19 ATEX 0008
Marking:	CE 0722
Apparatus category:	II 2G II 2D
Marking of explosion protection:	Ex eb IIC T6/T5 Gb Ex tb IIIC T80°C/T95°C Db
Ambient temperature ATEX:	-40°C ≤ T _a ≤ +50°C
Degree of protection:	IP 66 category 1
Resistance to shock:	IK 09
Protection class :	I (protective earthing)
Nominal voltage U_n:	690 V ±10%

Table of maximum currents:

Terminal	Conductor cross section [mm ²]	Maximum thermal current of terminals / cable [A]			
		T _{amax} = +40°C		T _{amax} = +50°C	
		Cable temperature stability ≥ 70°C II 2G - T6 II 2D - T80°C	Cable temperature stability ≥ 90°C II 2G - T5 II 2D - T80°C	Cable temperature stability ≥ 70°C II 2G - T6 II 2D - T80°C	Cable temperature stability ≥ 90°C II 2G - T5 II 2D - T80°C
300mm ²	185	330	430	280	370
	150	270	350	230	300
185mm ²	120	200	280	160	240
120mm ²	95	160	215	130	185
	70	120	160	95	140
	50	85	115	65	100

- For terminals from 50... 300 mm²
- Rated operational current up to max. 450 A depending on enclosure version and size

Busbar enclosure

MODEL CODE

TYPE	Cu busbar dim.	No. of SKX 20 enclosure	Conductor cross-section
SKX 20/1-120	3L+N+PE (20x10mm)	1	120 mm ²
SKX 20/2-185	3L+PE (30x10mm)	2	185mm ²
SKX 20/3-185	3L+PE (30x10mm)	3	

DIMENSION DRAWING (mm)

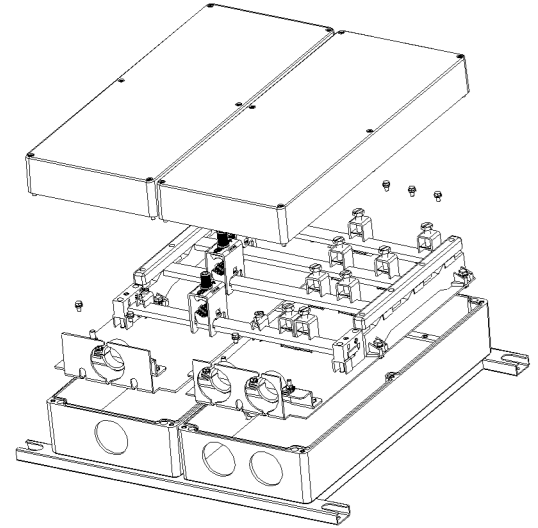
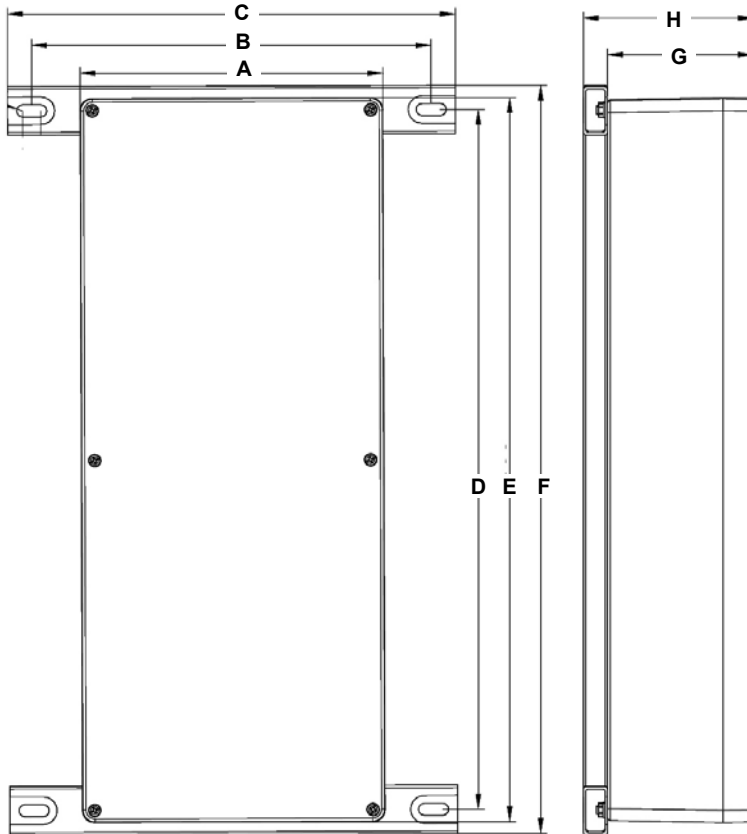

Type	A	B	C	D	E	F	H	G
SKX 20/1	250	330	370	580	600	620	140	120
SKX 20/2	504	583	623				180	160
SKX 20/3	758	836	876					

SPARE PARTS AND ACCESSORIES

SKETCH	DESCRIPTION	CODE	SKETCH	DESCRIPTION	CODE
	Cover	SKX 20/10-110		Terminal 35 mm ²	SKX 604016/10-170
	Gasket	SKX 20/10-130		Terminal 120 mm ²	SKX 604016/10-180
	Busbar holder	SKX 20/10-160		Terminal 300 mm ²	SKX 604016/10-190
	Busbar Cu 30x10	SKX 20/10-210		Strain relief set	SKX 20/10-220
	Busbar holder PE	SKX 20 / 10-150			

All technical data is relevant at the time of print.

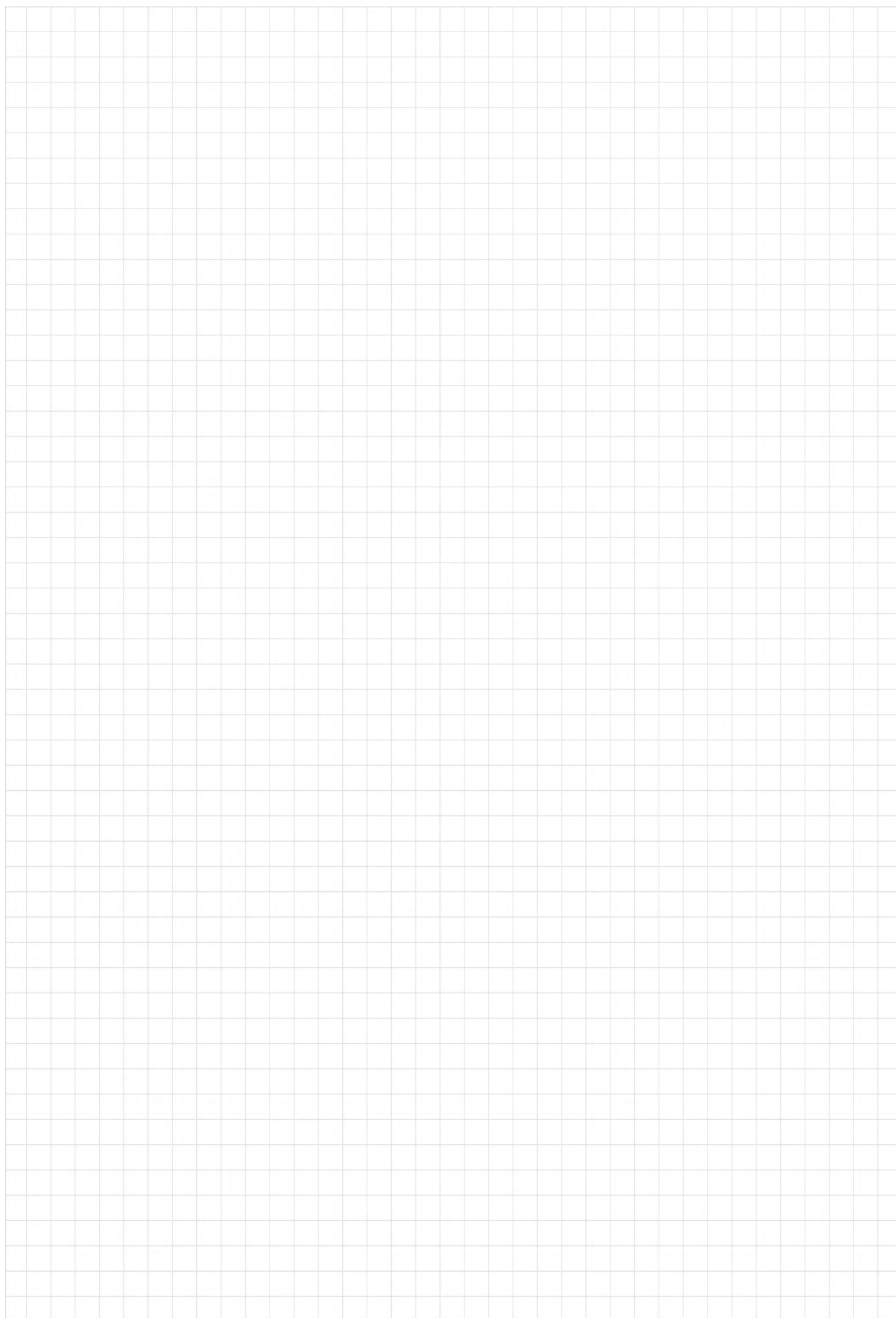

Control units



IP 66



- Enclosures made of glass-fibre reinforced polyester resin
- 4 basic enclosure sizes
- Alone or in various combinations of merged set
- Equipped with built-in devices
- ⇒ Control devices
- ⇒ Indicating lamps
- ⇒ Pushbuttons
- ⇒ Control switches
- ⇒ Ammeters



CONSTRUCTION

Enclosure: polyester plastic reinforced with glass fiber, color - black
Cover: with integrated thermoplastic elastomer gasket, closes with four M5/M6 stainless steel screws.

TECHNICAL DATA

Certificate:	FIDI 19 ATEX 0051X EAC RU C-HR.AB24.B.03291
Marking:	CE 0722
Apparatus category:	II 2GD, IM2
Marking of explosion protection:	Ex db eb IIC T6 Gb Ex db eb mb IIC T6 Gb Ex eb IIC T6 Gb Ex ia/ib IIC T6 Gb Ex tb IIIC T80°C Db Ex db eb I Mb Ex db eb mb I Mb Ex eb I Mb Ex ia/ib/ I Mb
Ambient temperature ATEX: EAC:	-20°C ≤ T _a ≤ +40°C / +50°C / +55°C -50°C ≤ T _a ≤ +50°C
Degree of protection:	IP 66 category 1
Resistance to shock:	IK 08
Protection class :	I (protective earthing)
Rated voltage:	630 V AC (with mantle terminals block SL5, SL8 U _i = 400V AC)
Thermal current I_{the} :	16 A max. at T _{amb} -20°C ÷ +40°C 10 A max. at T _{amb} -20°C ÷ +50°C
PE terminals (inside of the enclosure):	max. 2x4 mm ² +2x2,5 mm ² , 3x4 mm ² , 2x6 mm ²
Weight (only GRP boxes):	SKX 12 0.5 kg SKX 13 0,7 kg SKX 14 1.0 kg SKX 15 1.0 kg

MOUNTING

With screw kit through the housing holes ϕ 6 mm at the peaks the rectangle:

SKX 12: 75 x 50 mm
SKX 13: 75 x 100 mm
SKX 14: 75 x 150 mm
SKX 15/15H: 125 x 150 mm

Possible combinations and layout of indicators and actuators components

* mounting proposals and dimensions

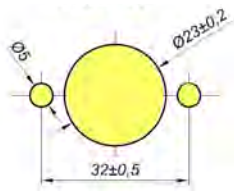

Switch actuator SMO 17/
Switch mounting

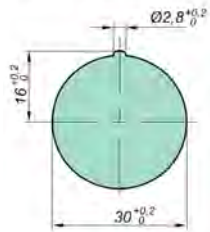

Pushbutton actuator SPO 01/
Front element of signal lamp SPO 02/
Pushbutton, signal lamp and potentiometer mounting

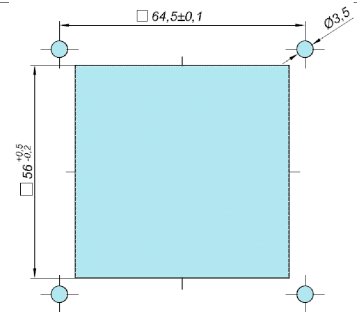

Front element of measuring instrument
(AM, VM) SAM 72
Measuring instrument mounting AM, VM

Enclosure type SKX 12

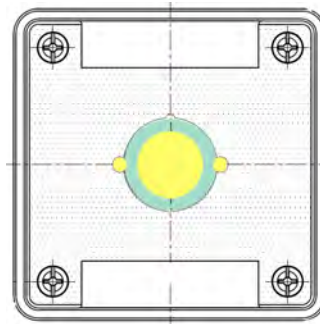
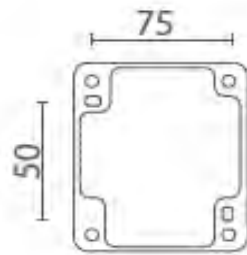
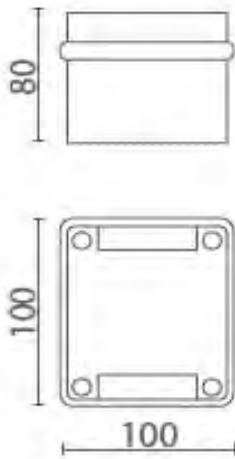

Max. No. of cable glands

cable gland side	M16	M20	M25
A-C	2	2	1
B-D	1	1	1

All technical data is relevant at the time of print.

SKX 12 ... SKX 15

Enclosure type SKX 13

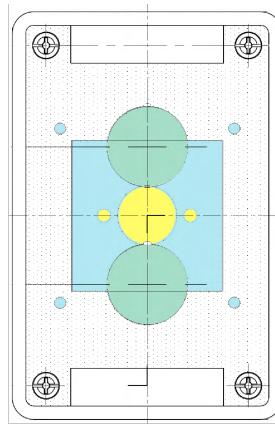
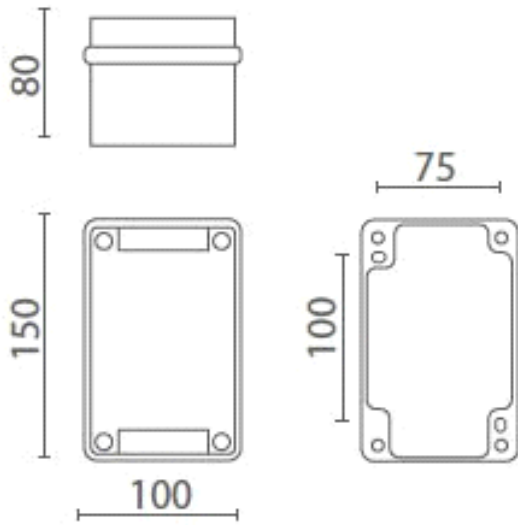

Max. No. of cable glands

cable gland side	M16	M20	M25
A-C	2	2	1
B-D	4	3	2

Enclosure type SKX 14

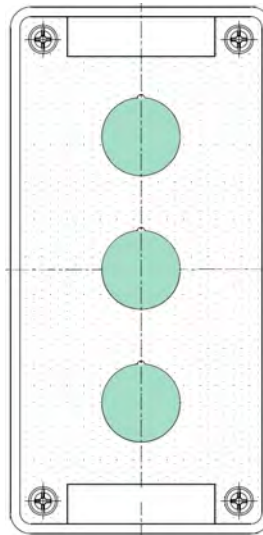
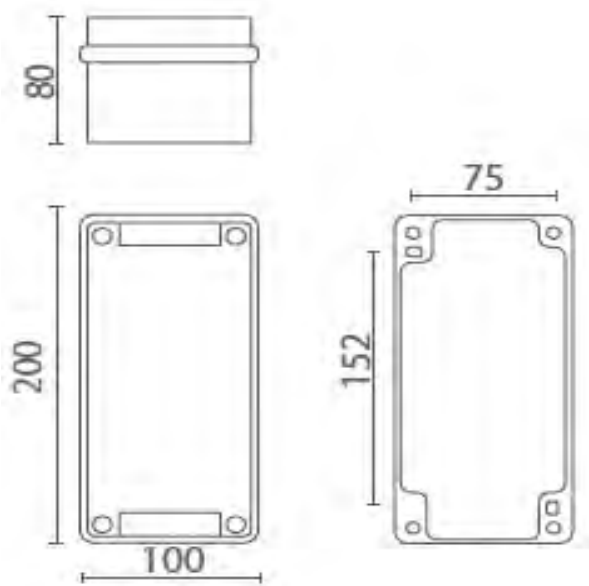

Max. No. of cable glands

cable gland side	M16	M20	M25	M32
A-C	2	2	1	1
B-D	6	4	3	2

Enclosure type SKX 15

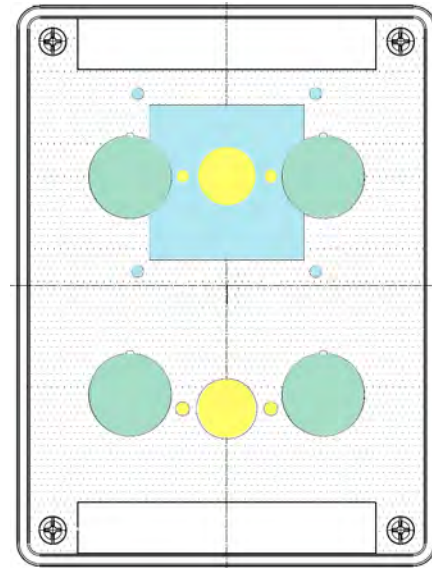
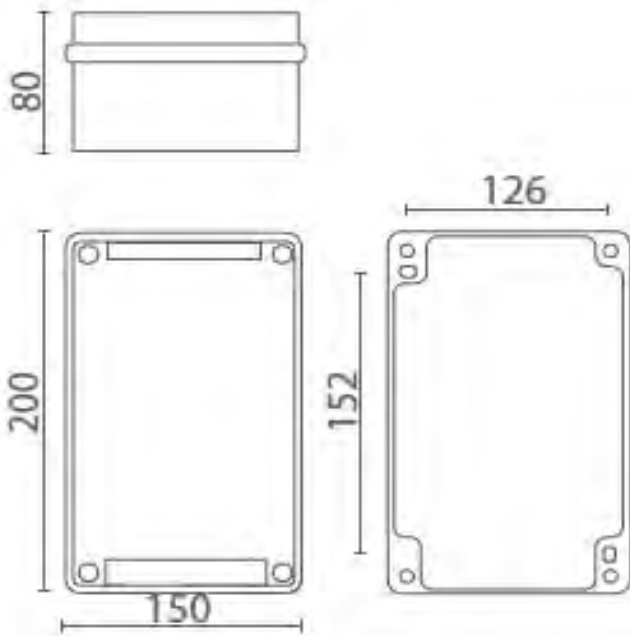

Max. No. of cable glands

cable gland side	M16	M20	M25	M32	M40
A-C	4	3	2	2	1
B-D	6	4	3	2	2

* with built-in N/PE busbar

cable gland side	M16	M20	M25	M32	M40
A-C	4	3	2	2	1
B-D	5	3	3	-	-

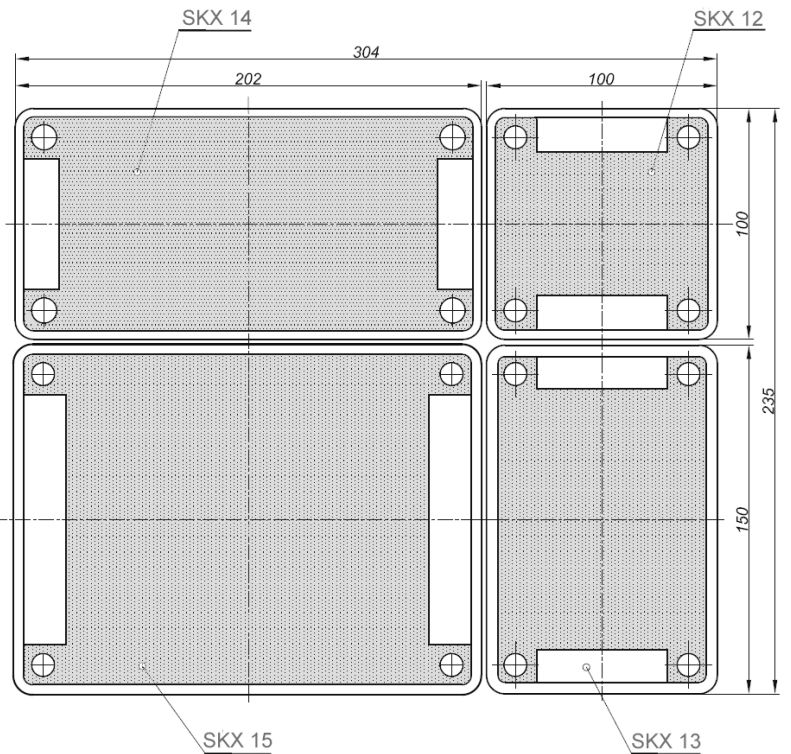
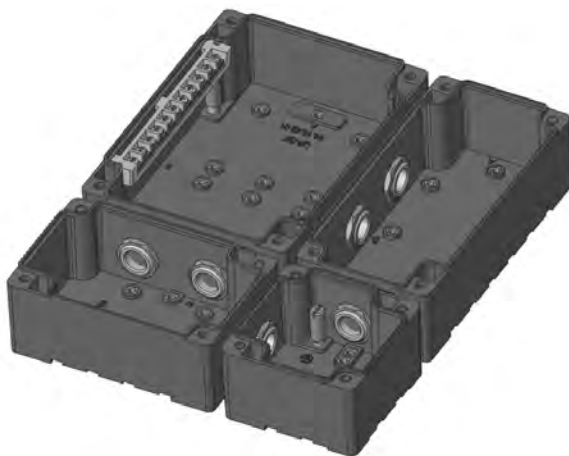

Various combinations of merged set (combination) of SKX enclosures



MODEL CODE

The program consists of serial control units and control units according to customer's request.

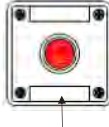
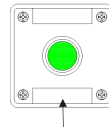
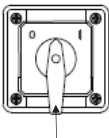
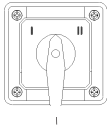
SKX 12/..

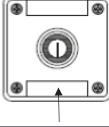
Type	Build-in components and actuator / indicator	Overview
SKX 12/1	Signal lamp SLP - red SPO 02/1 - cable gland SPU 25	
SKX 12/2	Signal lamp SLP - green SPO 02/2 - cable gland SPU 25	
SKX 12/3	Signal lamp SLP - white SPO 02/4 - cable gland SPU 25	-
SKX 12/21	Control switch SMS 03/1 - switch actuator SMO 17/1 - cable gland SPU 25	
SKX 12/22	Serial switch SMS 03/8 - switch actuator SMO 17/5 - cable gland SPU 25	0 - I - II - III
SKX 12/23	Control switch SMS 03/6 - switch actuator SMO 17/2 - cable gland SPU 25	
SKX 12/31	Pushbutton PBT 01 - Key-operated mushroom -head pushbutton actuator - cable gland SPU 25	-
SKX 12/32	Pushbutton PBT 01 - pushbutton actuator SPO 01/1 - cable gland SPU 25	
SKX 12/33	Pushbutton PBT 01 - pushbutton actuator SPO 01/2 - cable gland SPU 25	
SKX 12/34	Pushbutton PBT 01 - Mushroom-head pushbutton actuator - cable gland SPU 25	-
SKX 12/35	Pushbutton PBT 01 - Mushroom-head pushbutton actuator with protector - 2x cable gland SPU 20	-
SKX 12/36	Pushbutton PBT 011 - Key-operated pushbutton - 2x cable gland SPU 20	-
SKX 12/37	Potentiometer - cable gland SPU 25	-
SKX 12/62	5x4 mm2 EURO 4/35 grey on rail TH 35-7,5 - 2x SPU 25	-
SKX 12/63	5x4 mm2 EURO 4/35 blue on rail TH 35-7,5 - 2x SPU 25 blue	-

SKX 13/..

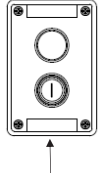
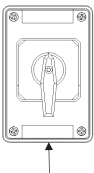
Type	Build-in components and actuator / indicator	Overview
SKX 13/1	2x pushbutton PBT 01 - SPO 01/1 - SPO 01/2 - cable gland SPU 25	
SKX 13/11	Pushbutton PBT 01 - SPO 01/1 - Signal lamp SLP - Front element of signal lamp SPO 02/2 - cable gland SPU 25	
SKX 13/10	Switch SMS 03/1 - switch actuator SMO 17/1 - cable gland SPU 25	
SKX 13/20	SMS 03/4 - SMO 17/2 - SPU 25	
SKX 13/30	SMS 03/5 - SMO 17/2 - SPU 25	
SKX 13/40	SMS 03/6 - SMO 17/2 - SPU 25	
SKX 13/60	SMS 03/3 - SMO 17/3 - SPU 25	
SKX 13/70	SMS 03/2 - SMO 17/1 - SPU 25	
SKX 13/80	SMS 03/7 - SMO 17/1 - SPU 25	
SKX 13/100	SMS 03/8 - SMO 17/5 - SPU 25	
SKX 13/110	SMS 03/9 - SMO 17/1 - SPU 25	
SKX 13/120	SMS 03/11 - SMO 17/2 - SPU 25	

SKX 14/..

Type	Build-in components and actuator / indicator	Overview
SKX 14/1	2x pushbutton PBT 01 - SPO 01/1 - SPO 01/2 - Signal lamp SLP - SPO 02/2 - cable gland SPU 25	
SKX 14/11	3x pushbutton PBT 01 - pushbutton actuator SPO 01/1 - SPO 01/2 - SPO 01/3 - cable gland SPU 25	-
SKX 14/21	Mantle terminals SL 8 - 8x cable gland SPU 25	-
SKX 14/22	3x signal lamp SLP front element of signal lamp SPO 02/1 - SPO 02/2 - SPO 02/3 - cable gland SPU 25	-
SKX 14/31	3x pushbutton PBT 01 - pushbutton actuator SPO 01/1 - SPO 01/2 Mushroom-head pushbutton actuator - cable gland SPU 25	-

SKX 15/..

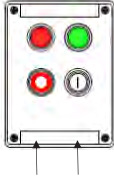
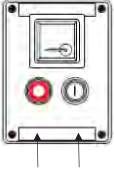
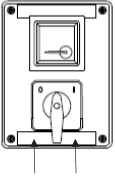
Type	Build-in components and actuator / indicator	Overview
SKX 15/1	2x pushbutton PBT 01 - SPO 01/1 - SPO 01/2 - 2x signal lamp SLP - 02/1 - SPO 02/2 - 2x cable gland SPU 25	
SKX 15/11-11	2x pushbutton PBT 01 - pushbutton actuator SPO 01/1 - SPO 01/2 - ammeter AM 72 100/1A - 2x cable gland SPU 25	
SKX 15/11-12	2xPBT 01 - SPO 01/1 - SPO 01/2 - AM 72 50/1 A - 2xSPU 25	
SKX 15/11-21	2xPBT 01 - SPO 01/1 - SPO 01/2 - AM 72 100/5 A - 2xSPU 25	
SKX 15/11-22	2xPBT 01 - SPO 01/1 - SPO 01/2 - AM 72 50/1 A - 2xSPU 25	
SKX 15/21-11	Switch - switch actuator SMO 17/1 - ammeter AM 72 100/1 A - 2x uvodnica SPU 25	
SKX 15/21-12	Switch - switch actuator SMO 17/1 - ammeter AM 72 100/1 A - 2x uvodnica SPU 25	
SKX 15/21-21	Switch - Switch actuator SMO 17/1 - ammeter AM 72 100/5 A - 2x uvodnica SPU 25	
SKX 15/21-22	Switch - switch actuator SMO 17/1 - ammeter AM 72 50/5 A - 2x cable gland SPU 25	
SKX 15/34	4x pushbutton PBT/1 - 2xSPO 01/1 - 2xSPO 01/2 - 2x cable gland SPU 25	-
SKX 15/50	Switch SMS 03/12 - SMO 17/2 - cable gland SPU 25	-
SKX 15/90	Switch SMS 03/10 - SMO 17/3 - cable gland SPU 25	-
SKX 15/51	Switch SMS 03/9 - SMO 17/1 - 2x pushbutton PBT/1 - SPO 01/1 - SPO01/2 - 2x cable gland SPU 25	-
SKX 15/65	4x mantle terminals SL5 - 8x cable gland SPU 25	-



IP 66



- Enclosures made of glass-fibre reinforced polyester resin **GRP**
- Stainless steel **AISI 316L**
- 3 basic enclosure sizes in GRP
- 3 basic enclosure sizes in stainless steel
- Alone or in various combinations of merged set
- Equipped with built-in components
 - ⇒ Control devices
 - ⇒ Indicating lamps
 - ⇒ Pushbuttons
 - ⇒ Switches
 - ⇒ Ammeters
- Version with hinged doors

CONSTRUCTION

Enclosure: polyester plastic reinforced with glass fiber, color - black
Stainless steel AISI 316L, brush finished, thickness 1.5mm

Cover: with integrated thermoplastic elastomer gasket, closes with four/six M5/M6 stainless steel screws.

TECHNICAL DATA

Certificate:	FIDI 19 ATEX 0052, FIDI 19 ATEX 0053 RU C-HR.AB24.B.03291, RU C-HR.AB24.B.03294
Marking:	0722
Apparatus category:	II 2GD
Marking of explosion protection:	Ex db eb mb ia/ib IIC T4...T6 Gb Ex tb IIIC T80°C Db
Ambient temperature ATEX: EAC:	-20°C ≤ T _a ≤ +50°C -50°C ≤ T _a ≤ +50°C
Degree of protection:	IP 66 category 1
Resistance to shock:	IK 08
Protection class :	I (protective earthing)
Rated voltage:	690 V AC (with mantle terminals block SL5, SL8 U _i = 400V AC)
Nominal current:	Up to 80 A
PE terminals (inside of the enclosure):	max. 2x4 mm ² +2x2,5 mm ² , 3x4 mm ² , 2x6 mm ²
Connection:	Depending on order requirements at the built-in components or at the terminal blocks. The rated operational voltage, the rated operational current and the rated cross-section depend on the terminal type used and the explosion protected components.

Control units SKX 16, SKX 18, SKX 20 are Ex combinations configured according to customer demand. Type designation consists of a basic type designation - SKX 16, SKX 18, SKX 20, "I" for enclosure made of SS AISI 316L and SRU number that represents the number of production and assigns to the increment.

Example: SKX 18 I / SRU -1280

- ⇒ *managing the combination of the housing MMK 403016*
- ⇒ *I - stainless steel enclosure AISI 316L*
- ⇒ *performed by production number 1280*

GRP enclosure SKX 17

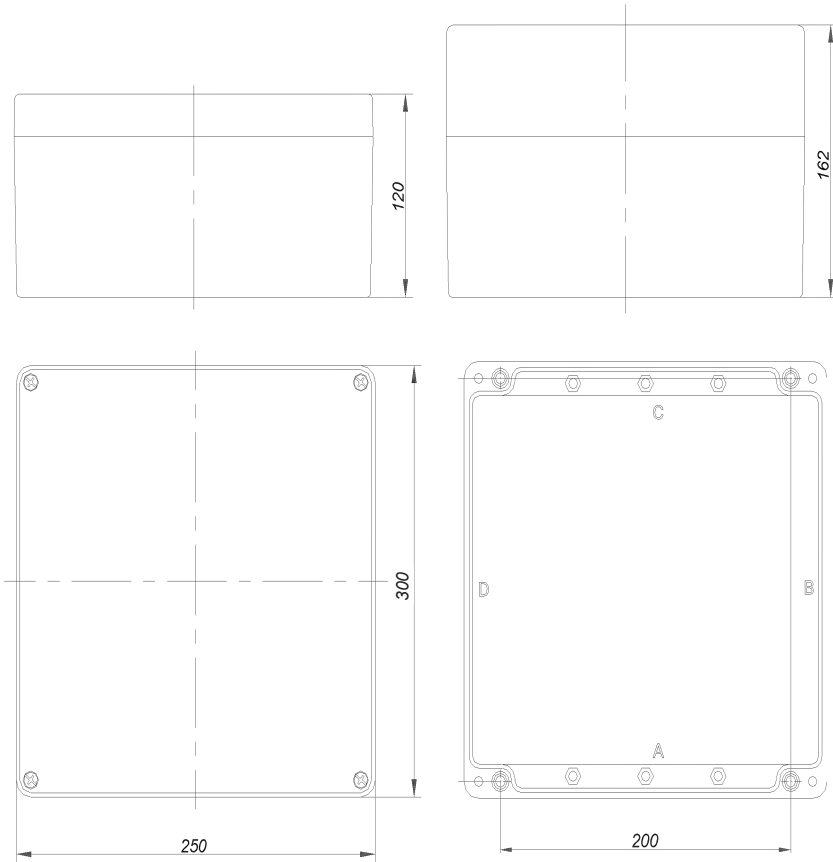

Side	Cable gland	M20	M25	M32	M40	M50	M63
B-D		9	9	5	3	3	2
A-C		7	5	3	3	1	1

GRP enclosure SKX 18

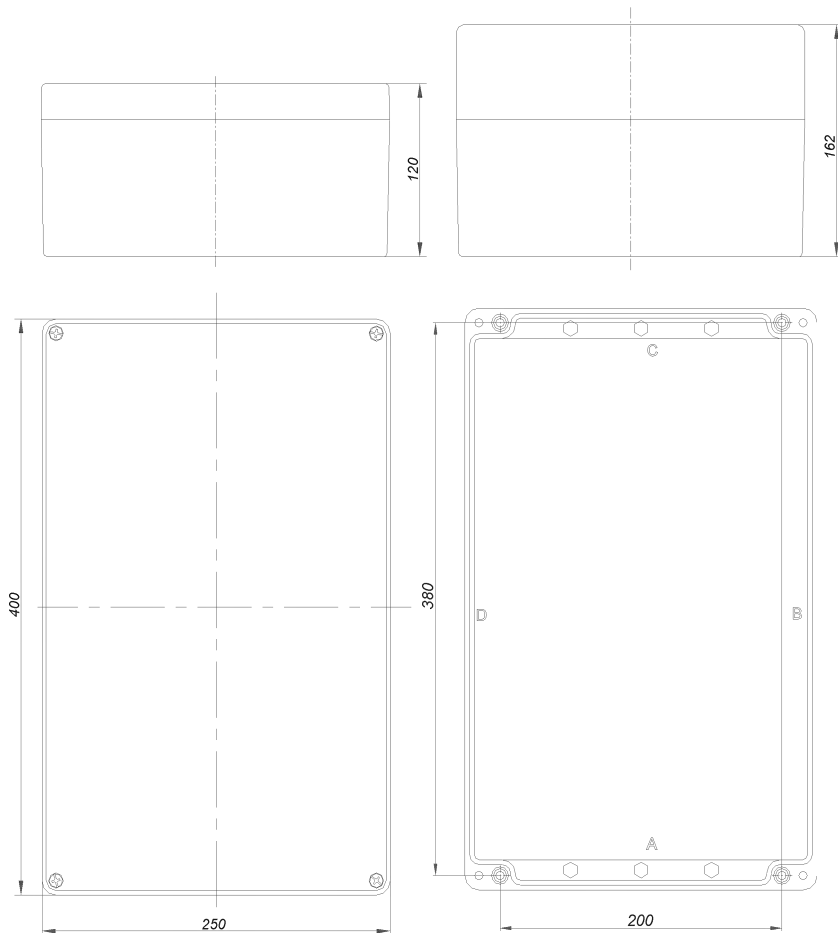

Side	Cable gland	M20	M25	M32	M40	M50	M63
B-D		17	15	9	6	5	4
A-C		9	7	3	3	2	2

All technical data is relevant at the time of print.

SKX 16 SKX 20

GRP enclosure SKX 20

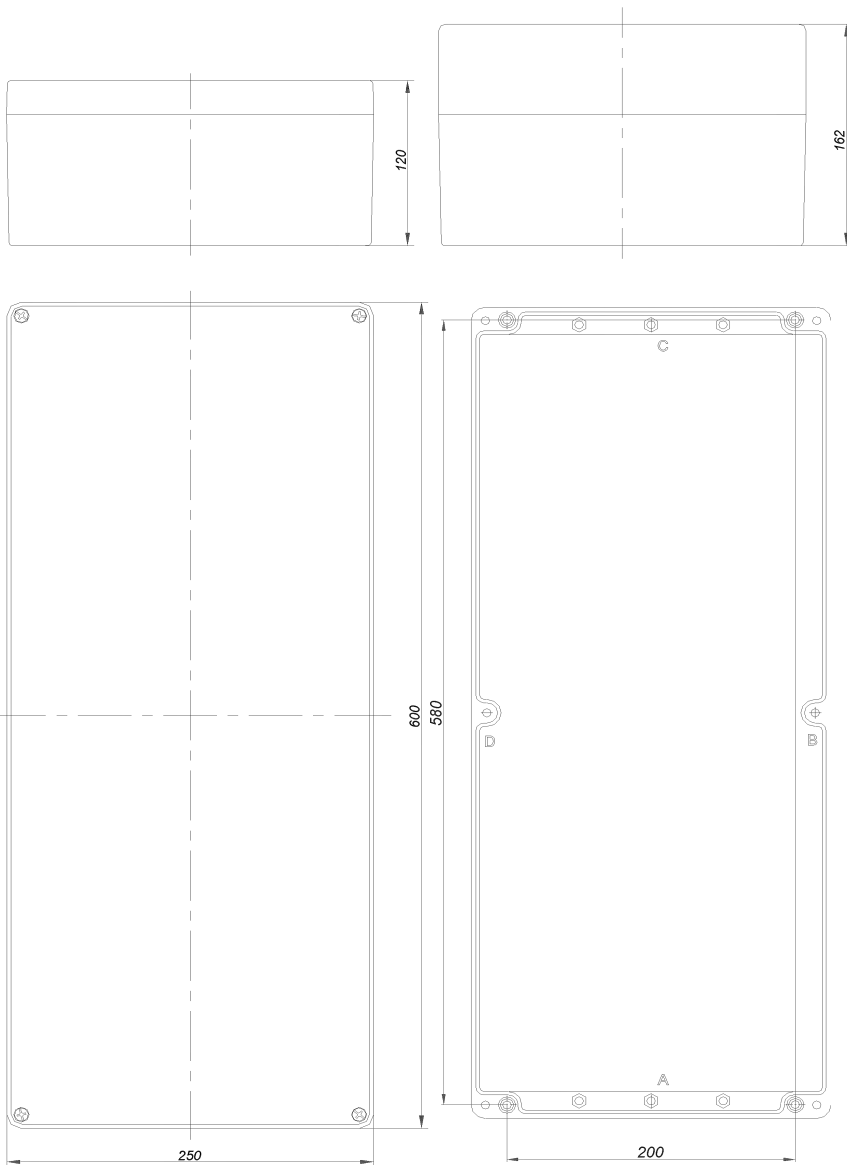

Side	Cable gland	M20	M25	M32	M40	M50	M63
B-D		24	22	12	8	6	6
A-C		9	7	3	3	2	2



Example: Ex control units with GRP enclosures

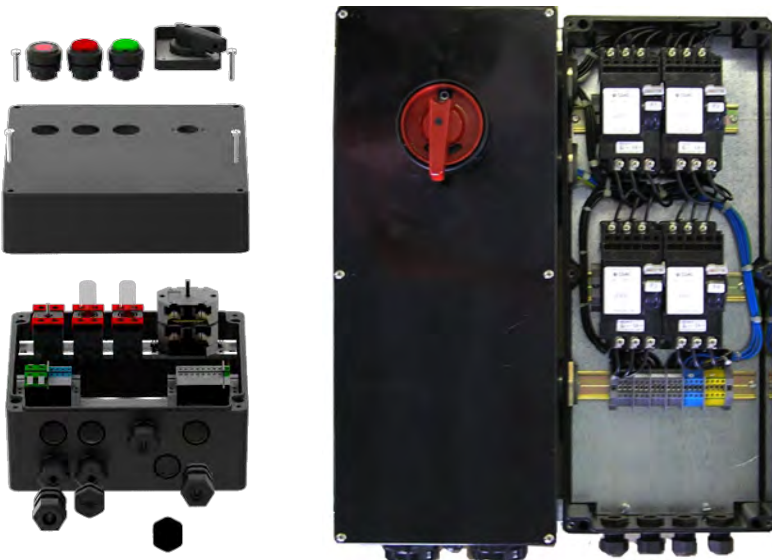

Stainless steel AISI 316L enclosure SKX 16 I, SKX 18 I, SKX 20 I

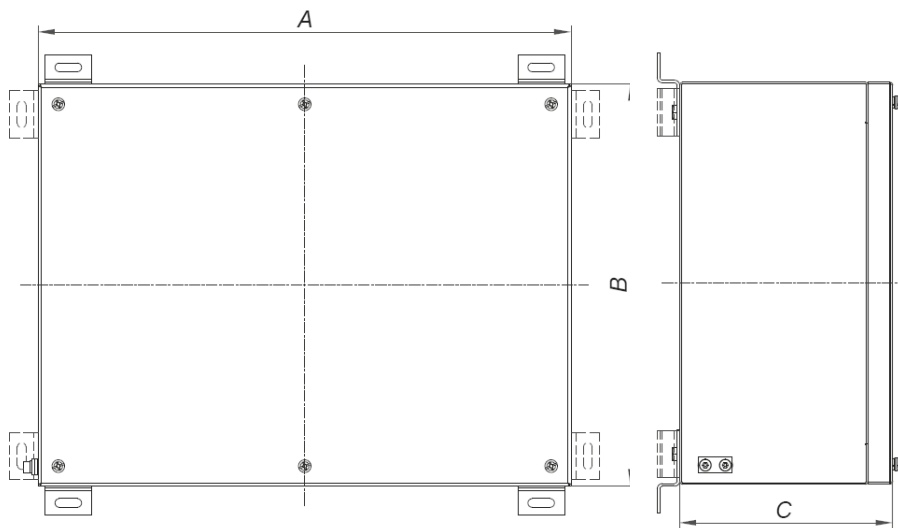

	A[mm]	B[mm]	C[mm]
SKX 16 I	300	200	120
SKX 18 I	400	300	160
SKX 20 I	600	400	160

MOUNTING

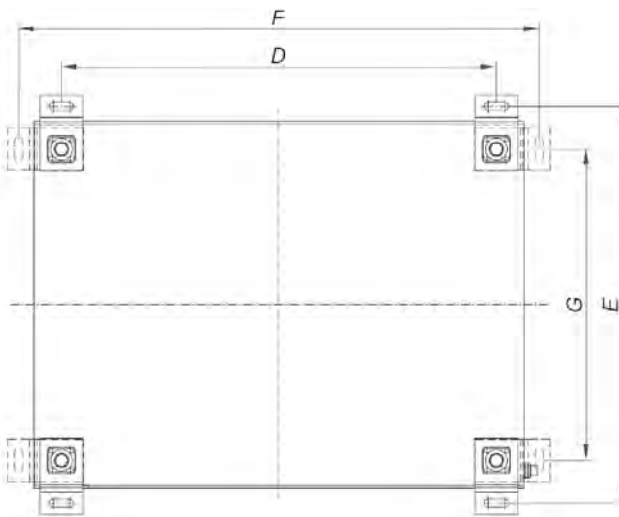

	D[mm]	E[mm]	F[mm]	G[mm]
SKX 16 I	255	227	330	152
SKX 18 I	355	327	430	252
SKX 20 I	555	427	630	352



Example: Ex control units with stainless steel AISI 316L enclosures









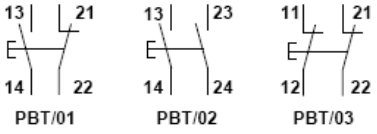

SKX 12 SKX 20

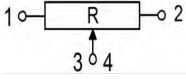

BUILD-IN COMPONENTS ACTUATORS AND INDICATORS

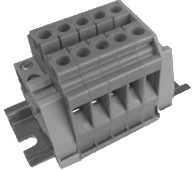





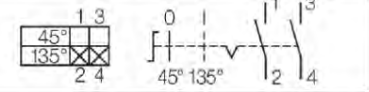
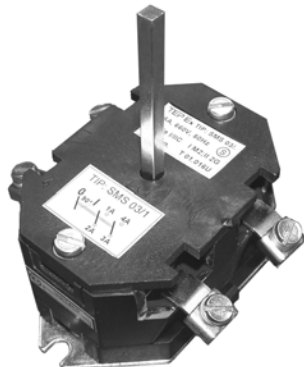

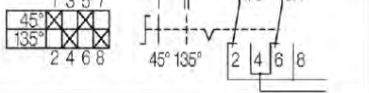
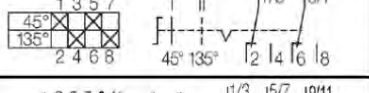
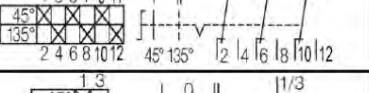
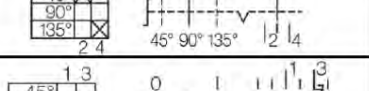
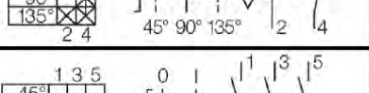
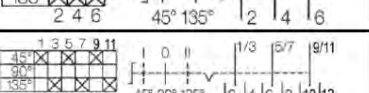
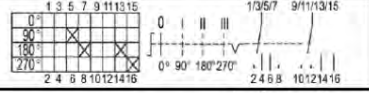
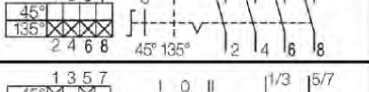
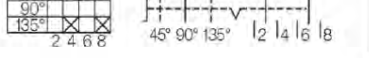
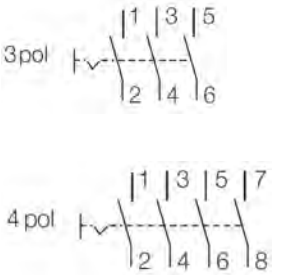
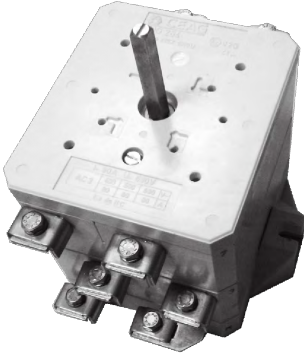

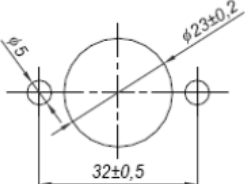
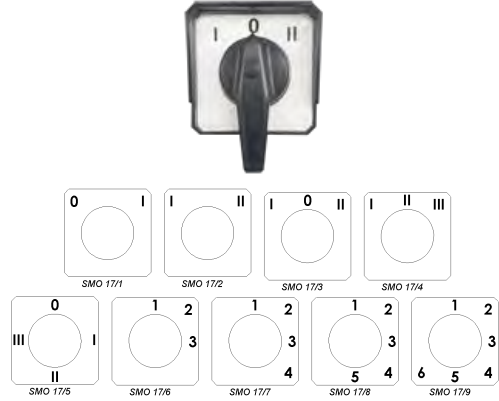
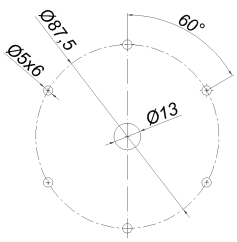

BUILD-IN COMPONENTS

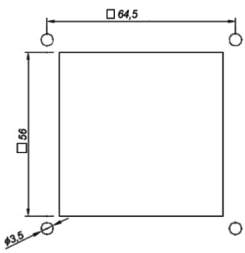
Description, type	Schema	Overview
<p>Pushbutton PBT/.</p> <ul style="list-style-type: none"> Rated voltage: 630V AC Rated current: 16A Terminals: 2,5 mm² 		
<p>Signal lamp SLP</p> <ul style="list-style-type: none"> Rated voltage: 12-250 V AC/DC Max. current: 20-8 mA Terminals: 2,5 mm² 		
<p>Potentionmeter</p> <ul style="list-style-type: none"> Rated voltage: 315 V AC/DC Rated power: 1W Scale: 0-100% / 270° Tolerance: ±20% Characteristic: linear Terminals: 2,5 mm² 	 <p>Resistance R: 1,0 kΩ 2,2 kΩ 4,7 kΩ 10 kΩ</p>	
<p>Measuring instruments AM 72, VM 72</p> <ul style="list-style-type: none"> Measuring range: AM: n/1 A, 0-20 mA, 0-25 A direct 4-20 mA VM: n/1A, 6-415V, 6-660 V Scale: according to customer demand Terminals: 1,5 - 4 mm² 	<p>-</p>	
<p>Terminals TH 35-7.5</p> <ul style="list-style-type: none"> 5 terminals 4mm² 2 terminals 16mm² Rated voltage: 690 V AC Rated current: 16 A 	<p>-</p>	
<p>N/PE busbar (only for SKX 15)</p> <ul style="list-style-type: none"> 11x max. 2x4mm² 	<p>-</p>	

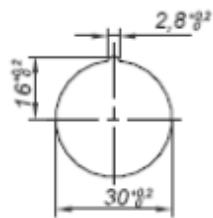

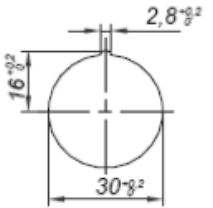

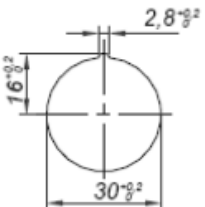





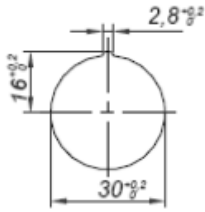

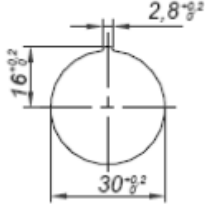

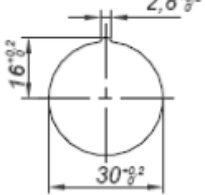
BUILD-IN COMPONENTS

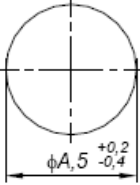
Description, type	Schema / type	Overview
<p>Control switch SMS 03/.</p> <ul style="list-style-type: none"> •Rated voltage: 630 V AC •Rated current: 16 A •Terminals: 2,5 mm² 	 <p>SMS 03/1</p>	
	 <p>SMS 03/4</p>	
	 <p>SMS 03/5</p>	
	 <p>SMS 03/6</p>	
	 <p>SMS 03/12</p>	
	 <p>SMS 03/3</p>	
	 <p>SMS 03/2</p>	
	 <p>SMS 03/7</p>	
	 <p>SMS 03/10</p>	
	 <p>SMS 03/8</p>	
	 <p>SMS 03/9</p>	
	<p>SMS 03/11</p>	
<p>Main current switch GHG 260</p> <p>Rated voltage: 690 V AC Rated current : 40 - 80 A Terminals: 16 - 25 mm²</p>	 <p>3 pol</p> <p>4 pol</p>	

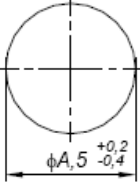

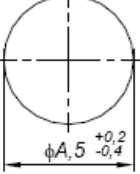
ACTUATORS AND INDICATORS

Description, type	Mounting	Overview																										
Switch actuator SMO 17/.																												
Switch actuator GHG 260 1006																												
Front element of measuring instruments SAM 72																												
Pushbutton actuator SPO 01/.		 <table border="1" data-bbox="1209 1274 1502 1618"> <thead> <tr> <th colspan="2">Type SPO 01/.</th> </tr> </thead> <tbody> <tr><td>SPO 01/01</td><td>0</td></tr> <tr><td>SPO 01/02</td><td>I</td></tr> <tr><td>SPO 01/03</td><td>II</td></tr> <tr><td>SPO 01/04</td><td>RED</td></tr> <tr><td>SPO 01/05</td><td>GREEN</td></tr> <tr><td>SPO 01/06</td><td>WHITE</td></tr> <tr><td>SPO 01/07</td><td>START</td></tr> <tr><td>SPO 01/08</td><td>STOP</td></tr> <tr><td>SPO 01/09</td><td>ON</td></tr> <tr><td>SPO 01/10</td><td>OFF</td></tr> <tr><td>SPO 01/11</td><td>BLACK</td></tr> <tr><td>SPO 01/12</td><td>BLUE</td></tr> </tbody> </table>	Type SPO 01/.		SPO 01/01	0	SPO 01/02	I	SPO 01/03	II	SPO 01/04	RED	SPO 01/05	GREEN	SPO 01/06	WHITE	SPO 01/07	START	SPO 01/08	STOP	SPO 01/09	ON	SPO 01/10	OFF	SPO 01/11	BLACK	SPO 01/12	BLUE
Type SPO 01/.																												
SPO 01/01	0																											
SPO 01/02	I																											
SPO 01/03	II																											
SPO 01/04	RED																											
SPO 01/05	GREEN																											
SPO 01/06	WHITE																											
SPO 01/07	START																											
SPO 01/08	STOP																											
SPO 01/09	ON																											
SPO 01/10	OFF																											
SPO 01/11	BLACK																											
SPO 01/12	BLUE																											
Front element of signal lamp SPO 02/.		 <table border="1" data-bbox="1209 1676 1502 1848"> <thead> <tr> <th colspan="2">Type SPO 02/.</th> </tr> </thead> <tbody> <tr><td>SPO 02/01</td><td>RED</td></tr> <tr><td>SPO 02/02</td><td>GREEN</td></tr> <tr><td>SPO 02/03</td><td>YELLOW</td></tr> <tr><td>SPO 02/04</td><td>TRANSPARENT</td></tr> </tbody> </table>	Type SPO 02/.		SPO 02/01	RED	SPO 02/02	GREEN	SPO 02/03	YELLOW	SPO 02/04	TRANSPARENT																
Type SPO 02/.																												
SPO 02/01	RED																											
SPO 02/02	GREEN																											
SPO 02/03	YELLOW																											
SPO 02/04	TRANSPARENT																											
Key-operated pushbutton actuator																												

BUILD-IN COMPONENTS

Description, type	Mounting	Overview
Mushroom-head pushbutton actuator (EMERGENCY-STOP)		
Key-operated mushroom-head pushbutton actuator (EMERGENCY-STOP)		
Potentiometer acuator		
Cable gland plastic Exe/Exi ISO 16 - ISO 40		
Cable gland for armoured cable ISO 16 - ISO 40		
Plug SPC .. ISO 16 - ISO M40		
Connection part SKX		

BUILD-IN COMPONENTS

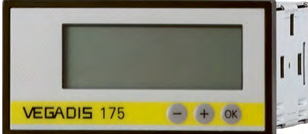
Description, type	Schema	Overview
<p>Ex Main fuse NH0 300XX, NH0, 301XX</p>	-	
<p>BUILD IN SOCKET 16 A (3p/5p), 32A (4p)</p>	-	
<p>RESIDUAL CURRENT CIRCUIT BREAKERS 2p/4p 25/40/63 A, 30 mA, 10 kA with or without auxiliary contact</p>	-	
<p>DIGITAL INDIKATORs</p>	-	

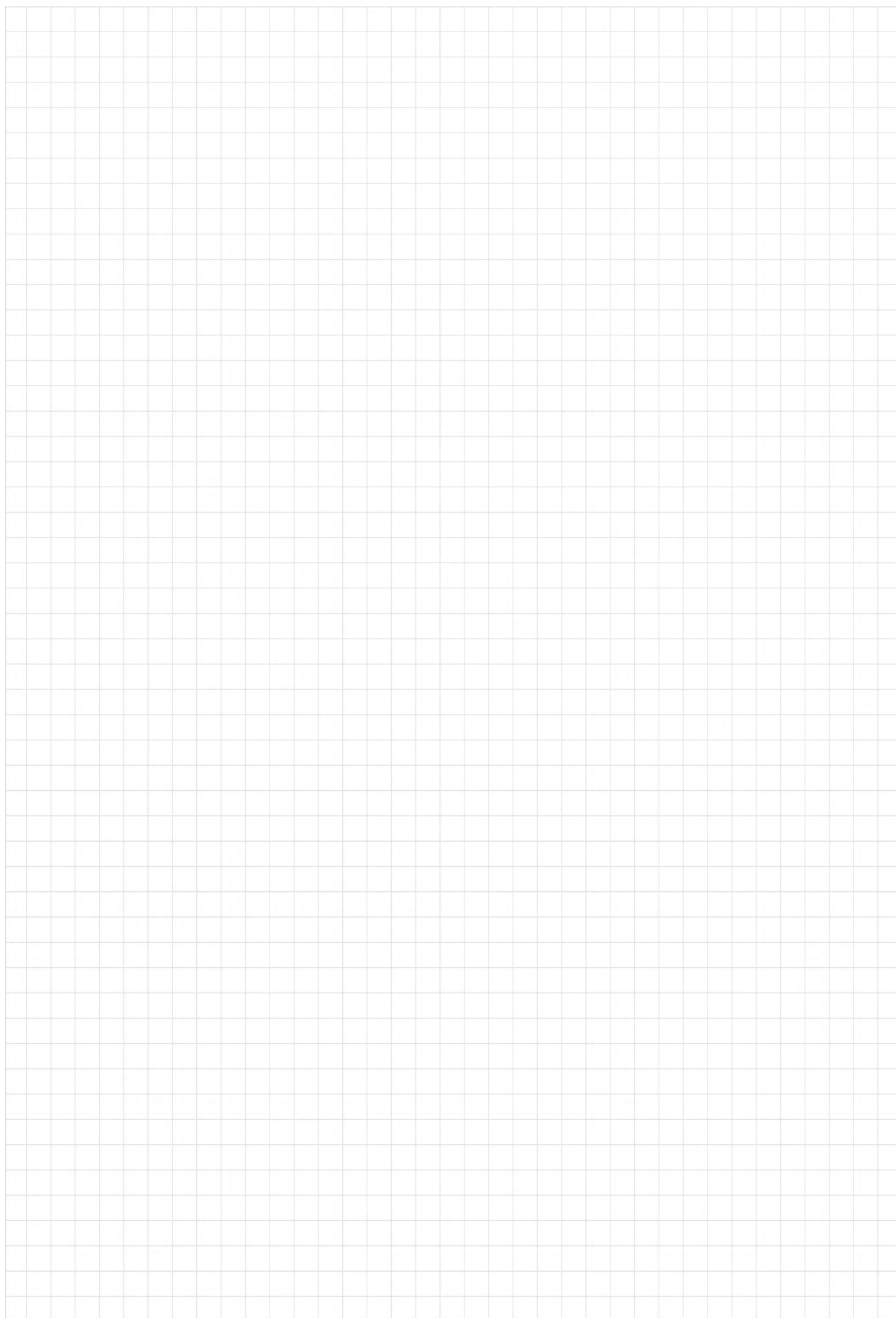

A photograph of an industrial refinery or chemical plant. The scene is dominated by tall, cylindrical distillation columns and a complex network of pipes and scaffolding. The sky is clear and blue. In the foreground, there are some green leaves and small white flowers, slightly out of focus. A semi-transparent blue rectangular box is overlaid on the upper part of the image, containing the text "Grounding control device" in white.

Grounding control device

IP 66



GGCD



- Active grounding system for static grounding and permanent monitoring
- Permanent removal of electrostatic charge during filling or emptying tanks (road tanks, railcar tanks, barrels)
- Two output contacts

CONSTRUCTION

Enclosure: polyester plastic reinforced with glass fiber, color - black
Cover: with integrated Thermoplastic elastomer gasket, closes with four M6 stainless steel screws.

TECHNICAL DATA

Certificate:	FIDI 19 ATEX 0050, EAC RU C-HR.AB24.B.03293
Marking:	0722
Apparatus category:	II 2GD
Marking of explosion protection:	Ex eb db [ib] mb IIC T5 Gb Ex tb IIIC T80° Db
Ambient temperature ATEX: EAC:	-20°C ≤ T _a ≤ +50°C -50°C ≤ T _a ≤ +50°C
Degree of protection:	IP 66 category 1
Resistance to shock:	IK 08
Protection class :	I (protective earthing)
Rated voltage:	230 V ± 10%
Rated current:	50 mA
Frequency:	50Hz
Output circuit:	2 NO/NC Un=250VAC, In=8A / 230V, 4A at cosφ=0.4
Cable entry:	3 x M25 - power supply, two output circuit 4 x M25 - 2x connection clamp , 2x wire to equipotential busbar or grounding
Weight:	6 kg (without clamp and cable) weight of clamps with 10 m cable ca. 2,5 kg
Packing:	The packing contains: 1 pcs 430x350x230 mm

Grounding and grounding control device





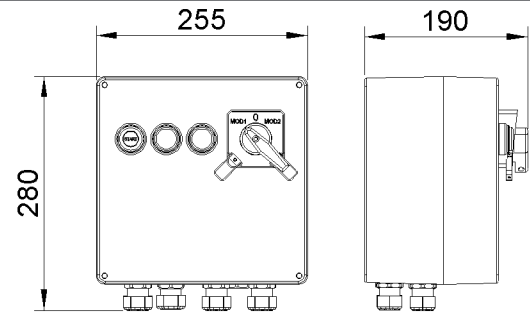

MODEL CODE

DIMENSION DRAWING (mm)

MODEL CODE	DESCRIPTION
GGCD-01/K1	Type with one Clamp with 10m spiral cable
GGCD-01/K2	Type with two Clamps with 10m spiral cable

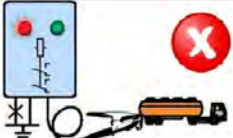

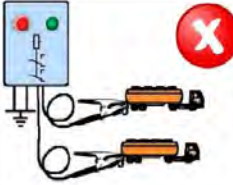
Principle of work for GGCD-01/..

State of earthing process		Reaction of the earthing monitoring device
	GGCD 01/K1 is not correct connected and turned ON. Clamp is not connected, grounding equipment not in use	Earthing incorrect • Red indicating lamp ON • Green indicating lamp OFF • Contact OPEN
	GGCD 01/K1 is correct connected and turned ON, but clamp is directly grounded, e.g. via the loading platform	Earthing incorrect (only MOD 2) • Red indicating lamp ON • Green indicating lamp OFF • Contacts OPEN
	GGCD 01/K1 is correct connected and turned ON. Clamp connected to tank vehicle.	Earthing OK • Red indicating lamp OFF • Green indicating lamp ON • Contacts CLOSED
	GGCD 01/K1 is correct connected and turned ON, but cable to the grounding is disconnected.	Earthing incorrect • Red indicating lamp ON • Green indicating lamp OFF • Contacts OPEN
	GGCD 01/K1 is correct connected and turned ON. Clamp connected to tank vehicle. Tank vehicle is grounded subsequently (e.g. via the loading arm).	Earthing OK • Red indicating lamp OFF • Green indicating lamp ON • Contacts CLOSED
	GGCD 01/K2 is correct connected and turned ON. Two clamps are connected on two separate object grounding.	Earthing incorrect • Red indicating lamp ON • Green indicating lamp OFF • Contacts OPEN
	GGCD 01/K2 is correct connected and turned ON. Two clamps are connected on one object grounding.	Earthing OK • Red indicating lamp OFF • Green indicating lamp ON • Contacts CLOSED

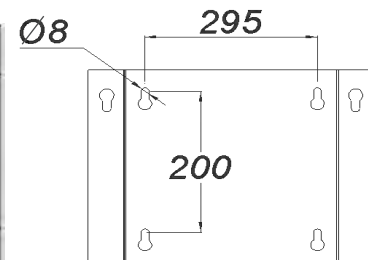

Ex grounding and grounding control device GGCD with cable protection

All technical data is relevant at the time of print.

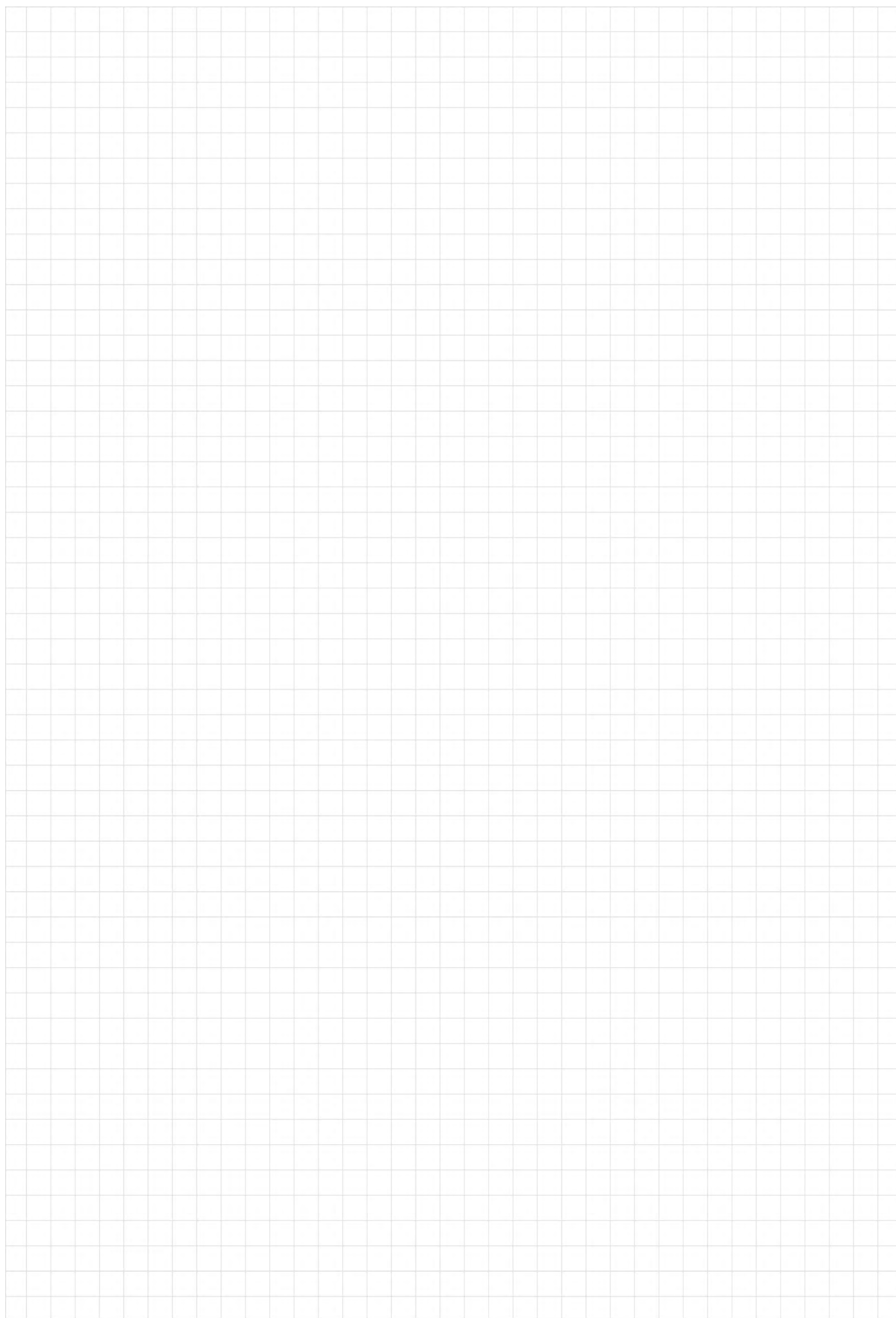

An aerial photograph of a large offshore oil rig in the middle of the ocean. The rig is a complex of white metal structures, including a central derrick, various platforms, and a helipad on the left. A semi-transparent blue rectangular box is overlaid on the upper part of the rig, containing the text "Distribution cabinets" in white. The ocean is a deep blue with some white foam from the rig's operations.

Distribution cabinets

Zone



R3002...R3006

IP 66



- Enclosure in sheet steel
- 5 basic enclosure sizes
- Enclosures can be combined (modular system)
- Available as empty enclosures or as completely fitted and wired control and distribution units
- For use in underground mines
- Cable entries available:

Direct : cable glands,

Indirect : via Ex e enclosure multiwire bushing, conductor insulator

CONSTRUCTION

Enclosure: sheet steel (Exd enclosure 12mm thickness, Exe enclosure 3mm thickness)
Gasket: EPDM formed gasket

TECHNICAL DATA

Certificate:	Ex FIDI 19 ATEX 0058X , RU C-HR.AB24.B.03297
Marking:	CE 0722
Apparatus category:	II 2G II 2D I M2
Marking of explosion protection:	Ex db eb I/II C T6 Gb Mb Ex tb IIIC Db
Ambient temperature ATEX:	-20°C ≤ T _a ≤ +50°C
EAC:	-50°C ≤ T _a ≤ +50°C
Degree of protection:	IP 66 category 1
Resistance to shock:	IK 09
Protection class :	I (protective earthing)
Rated voltage:	Up to 690 V AC
Rated current:	Up to 500 A (depends upon built-in device)
Terminal cross-section:	240 mm ²
Weight:	
- Enclosure R3002	70 kg
- Enclosure R3003	18 kg
- Enclosure R3004	47 kg
- Enclosure R3005	15 kg
- Enclosure R3006	9 kg
Color:	Yellow, RAL1016 (other color on request)
Mounting types:	temporary wall-mounted free-standing (with or without protection canopy)

Distribution cabinets

DIMENSION DRAWING (mm)

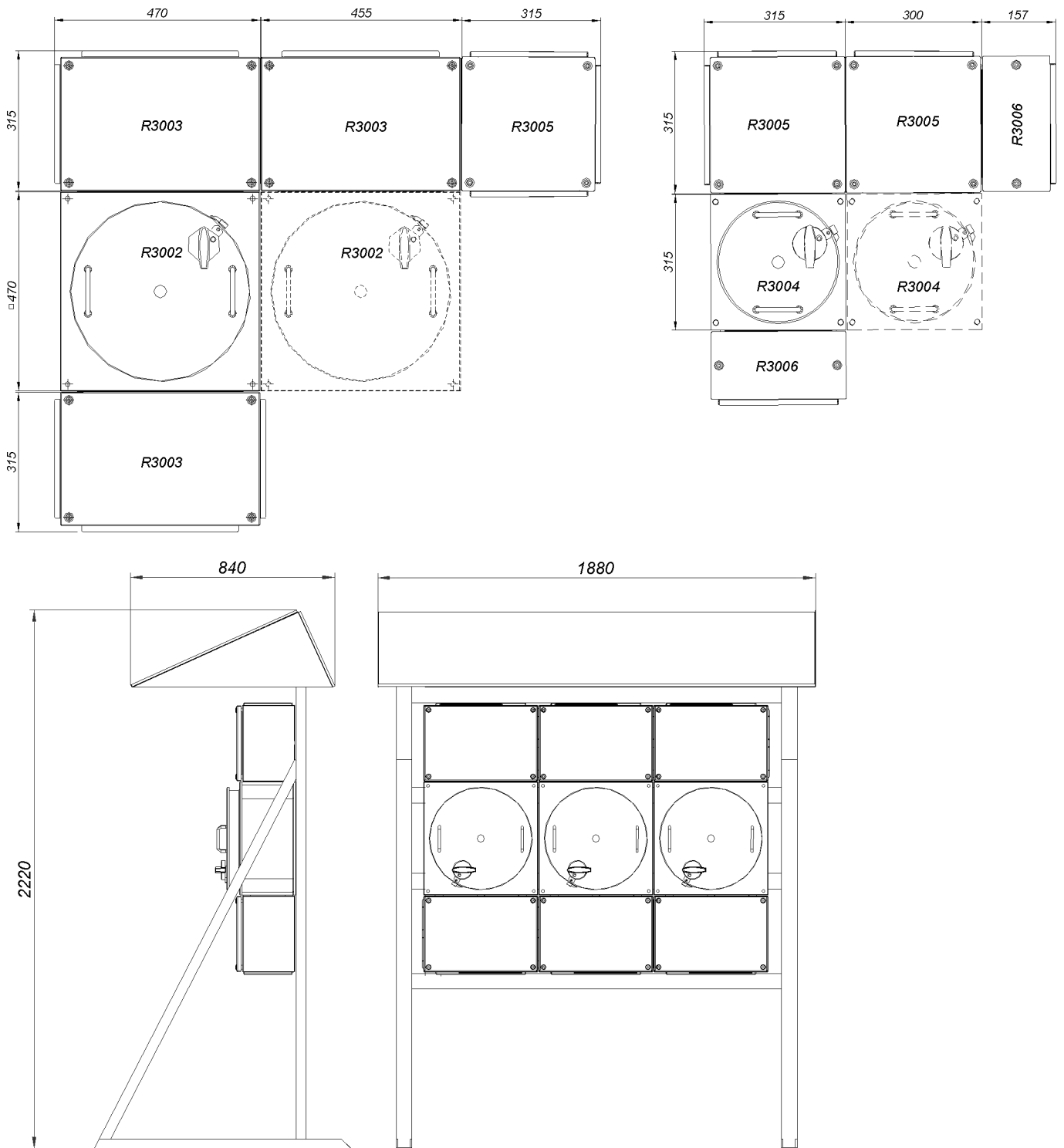

Free-standing modular system with protection canopy

All technical data is relevant at the time of print.

A distribution cabinets type R3002 and R3004 is made of steel with Ex d flameproof protection type. Closing of the cabinet is of threaded type and is protected against opening by lock switch, so that it can be opened only when it is not under voltage. The units is protected against corrosion by its painting inside and outside.

Ex d steel enclosures (type R3002 and R3004) and Ex e sheet steel enclosures (type R3003, R3005, R3006) can be used as single enclosures and combinations.

The dimensions of the enclosures are so designed that they can be combined into a large modular unit. A large number of components, such as contactors, switches, instruments and PLCs can be built into these enclosures. Naturally, customer-supplied equipment can also be incorporated into the layout. The equipment layout is designed by us to customer's requirements. Cable entry is either direct (cable glands or conduit entries) or indirect via an Ex e enclosures type R3003, R3005, R3006.

The "flameproof" type protection 'Ex d' is based on the principle that electrical components which may cause sparks or arcing in normal operation (switches, contactors etc.) are in an enclosure constructed so that it will contain an explosion of flammable gas or vapor and will not permit ignition of a surrounding explosive atmosphere. Further, the temperature of the outside surface of the enclosures must not exceed the prescribed temperature limit for the appropriate temperature class. That means, the heat loss from the components fitted must not exceed a specified value.

Data required for the layout of control and distribution boards

We produce distribution cabinets according to customer requirements and basis to the project data:

- the required minimum type of protection
- as appropriate, details of the hazardous atmosphere for which the equipment must be suitable
- single line or wiring diagram
- schematic for control systems
- operating, auxiliary and control voltages
- frequency
- power and current ratings of connected loads
- quantities and types of components required, e.g. contactors, switches, circuit-breakers, fuses, thermal relays, instruments, terminals etc.
- quantity and types of cables
- number and size of conductors
- quantity and location of entries (from top, bottom, side, center)
- environmental conditions
- method of installation

Examples of Ex distribution cabinets



Examples of wiring diagram for distribution cabinets

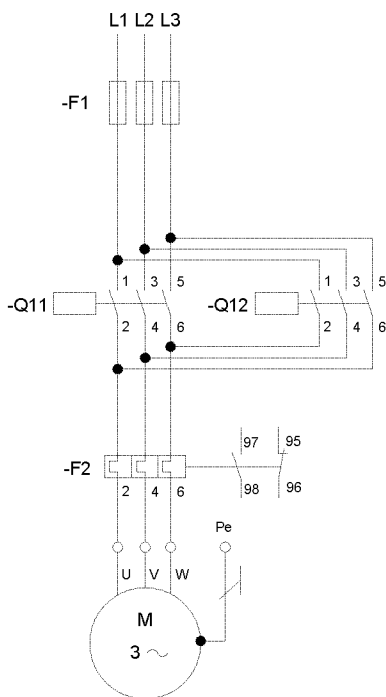

A) Direct on line start of three phase motor;
two directions of rotation

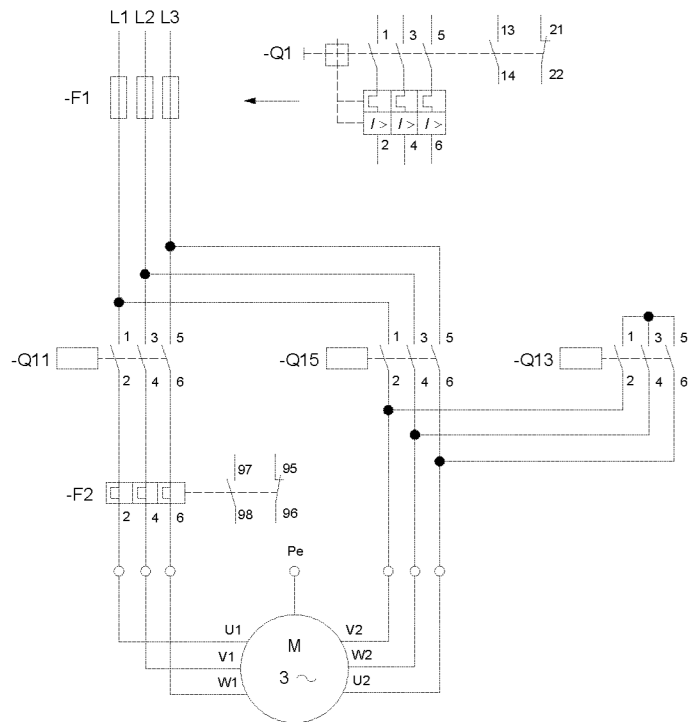

B) STAR-DELTA switching of three phase motor

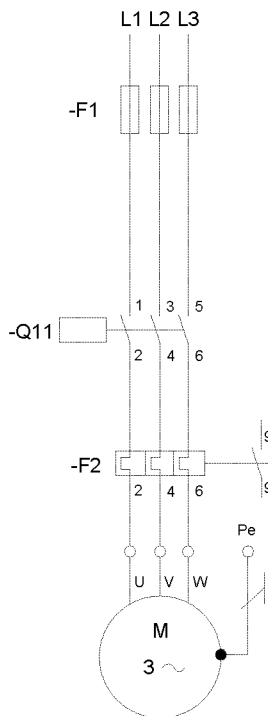

C) Direct on line start of three phase motor

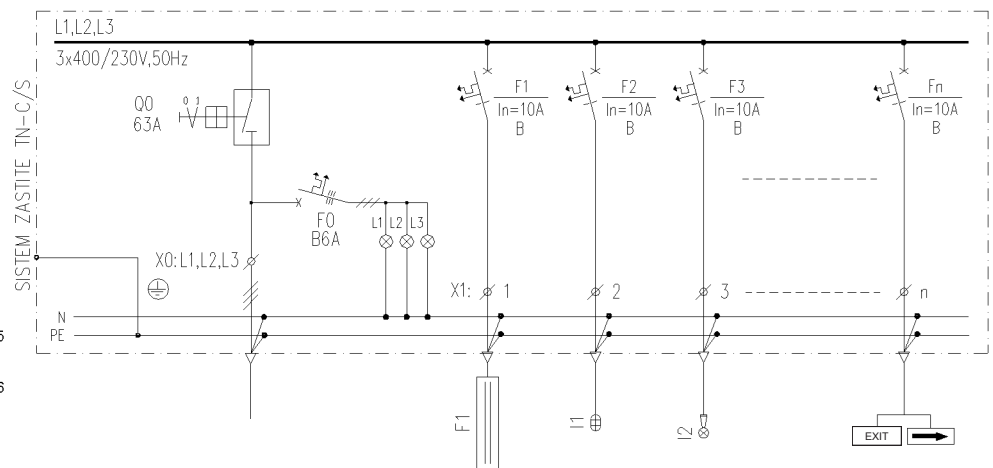

D) Light fittings control panel

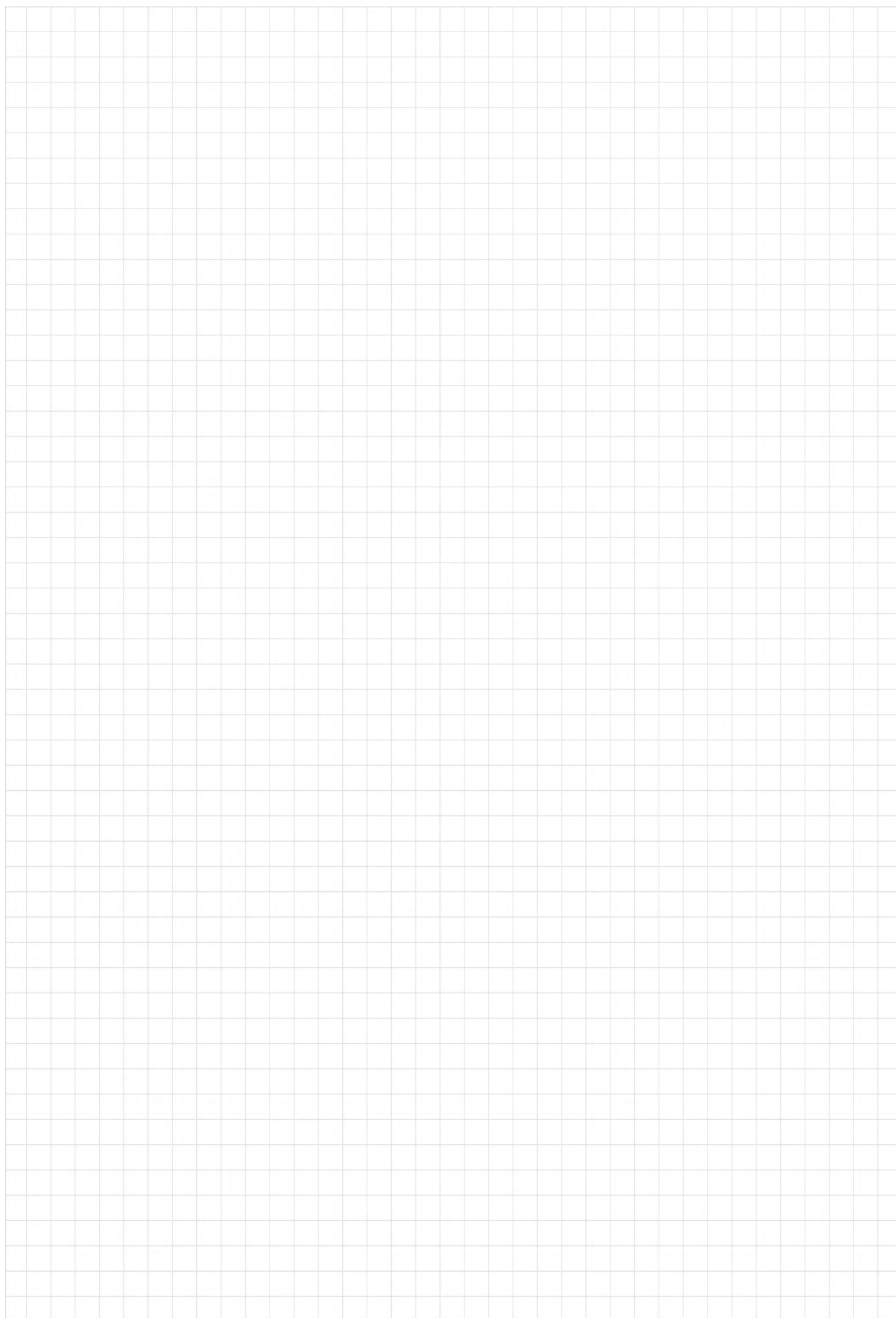

Portable lighting Signalling devices Accessories



Zone



DF1013 / DF104 / DS-14

LED

IP 68



TECHNICAL DATA type DF1013

Apparatus category:	II 1G
Marking of explosion protection:	Ex ia IIC T4 Ga
Ambient temperature:	-20 °C ≤ T _{amb} ≤ +40°C
Degree of protection:	IP 68
Luminous flux:	60 lm
Length of light beam:	130 m
Battery:	4x AA type
Autonomy:	app. 14 hours
Weight:	100 g (without battery)
Dimension:	175x45x45 mm



Push Button



LED

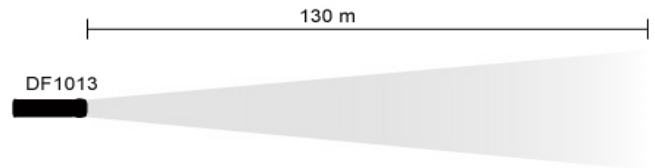

- For inspection and maintenance work

Torchlights / headlamp

TECHNICAL DATA type DF104

Apparatus category:	II 1G
Marking of explosion protection:	 Ex ia IIC T4 Ga
Ambient temperature:	$-20\text{ °C} \leq T_{\text{amb}} \leq +40\text{ °C}$
Degree of protection:	IP 68
Luminous flux:	43 lm
Length of light beam:	32 m
Battery:	3x C type
Autonomy:	app. 70 hours
Weight:	190 g (without battery)
Dimension:	220x60x85 mm



12 Ø5 LEDs



Push Button

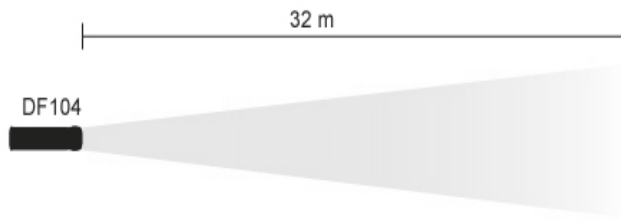

TECHNICAL DATA type DS-14 (headlamp)

Apparatus category:	II 1G
Marking of explosion protection:	 Ex ia IIC T4 Ga
Ambient temperature:	$-20\text{ °C} \leq T_{\text{amb}} \leq +40\text{ °C}$
Degree of protection:	IP 67
Luminous flux:	75lm / low mode , 150lm / High mode
Length of light beam:	75m / 100m
Battery:	3x AAA type
Autonomy:	app. 4 hours
Weight:	145 g (without battery)
Dimension:	80x50x45 mm



HELMET MOUNTABLE



RUBBERISED BUTTON



SMOOTH REFLECTION



LOCKING BATTERY COMPARTMENT

All technical data is relevant at the time of print.

XT-70

LED

IP 67



- Ultra bright high power LED light 350+ lumens
- Spot and flood switchable beam options
- Up to 11 hours duration on full power, 22 hours in powersave mode
- IP67 certified
- Quick charge, from 2 hours

TECHNICAL DATA type XT-75

Apparatus category:	II 2GD
Marking of explosion protection:	Ex ia op is IIC T4 Gb Ex is op is IIIB T185°C Da
Ambient temperature:	-30°C ≤ T _{amb} ≤ +40°C
Degree of protection:	IP 67
Luminous flux:	350+ lm
Light source:	High power LED 2x white
Battery:	Rechargeable battery, Lithium-Ion type XT-204
Compatible Charger:	XT-200L 12-24Vdc / XT-200H 90V-254Vac
Autonomy:	Up to 7,5 / 15 hours
Weight:	1,2 kg
Dimension:	190x120x136 mm

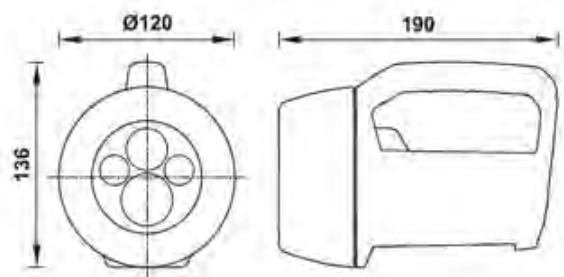
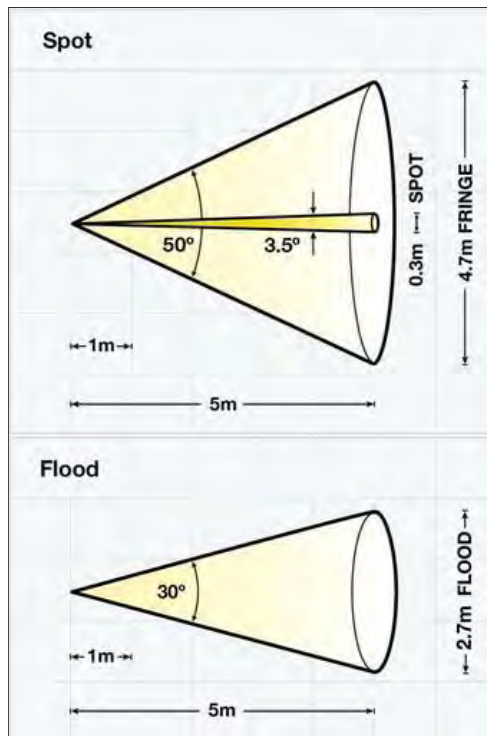

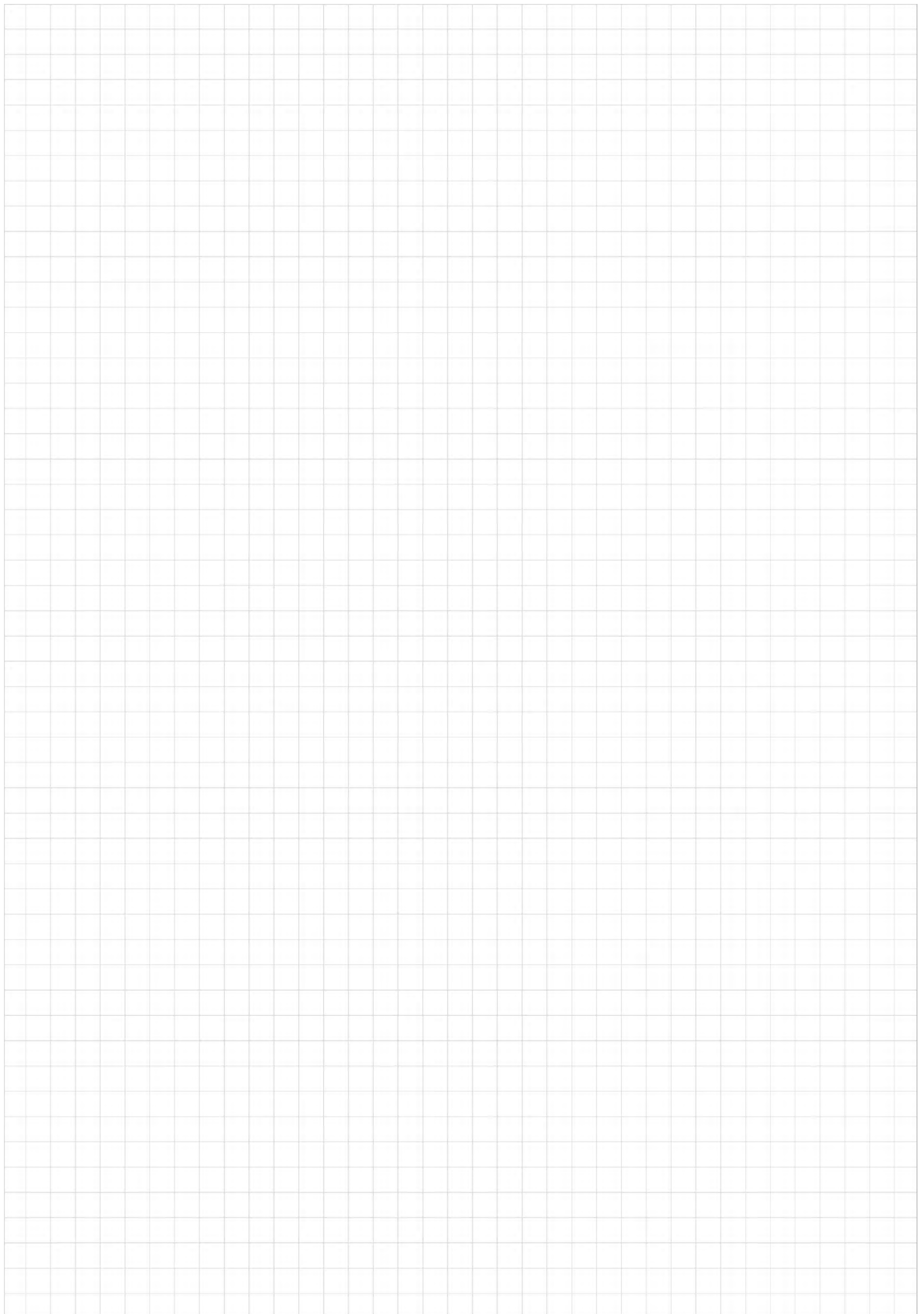

LED

IP 66



PLFS 50 LED PR



- Highest efficiency with luminous efficacy up to 170lm/W
- High color rendering index CRI 80
- Estimated service life 70 000 hours
- With OVP, OCP, OTP protection
- Autonomous reactivation after recovery
- Junction box, connection cable (20m, 50m), Ex socket/plug (on request)

CONSTRUCTION

Housing: aluminium powder painted casting
 Diffuser: borosilicate glass,
 Accessories: protected galvanized steel gird
 Gasket: silicon

TECHNICAL DATA

Certificate:	FIDI 19 ATEX 0030
Marking:	CE 0722
Apparatus category:	II 2G II 2D
Marking of explosion protection:	Ex db eb op is IIC T6/T5 Gb Ex tb op is IIIC T80°C/T85°C Db
Ambient temperature:	-40°C ≤ T _{amb} ≤ +40°C
Degree of protection:	IP 66 category 1
Resistance to shock:	IK 08
Protection class :	I (protective earthing)
Rated voltage:	90 - 305 V AC 127 - 431 V DC
Frequency:	50Hz / 60Hz
Rated power:	60W
Luminous flux:	10 200 lm
Weight:	8,5 kg

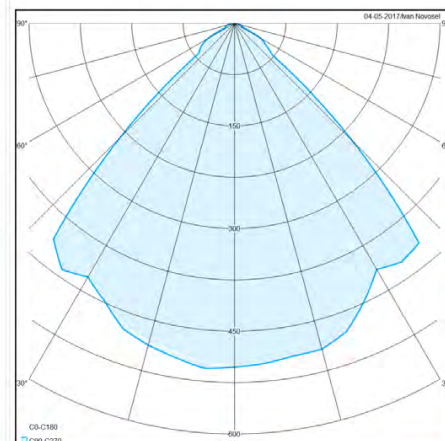
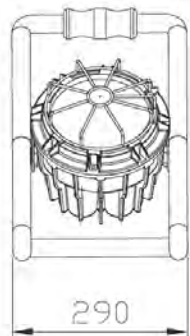
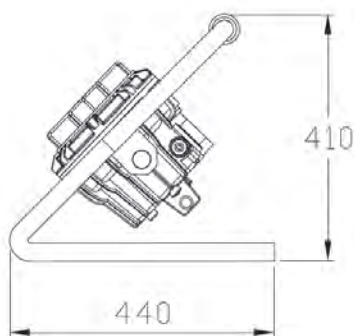

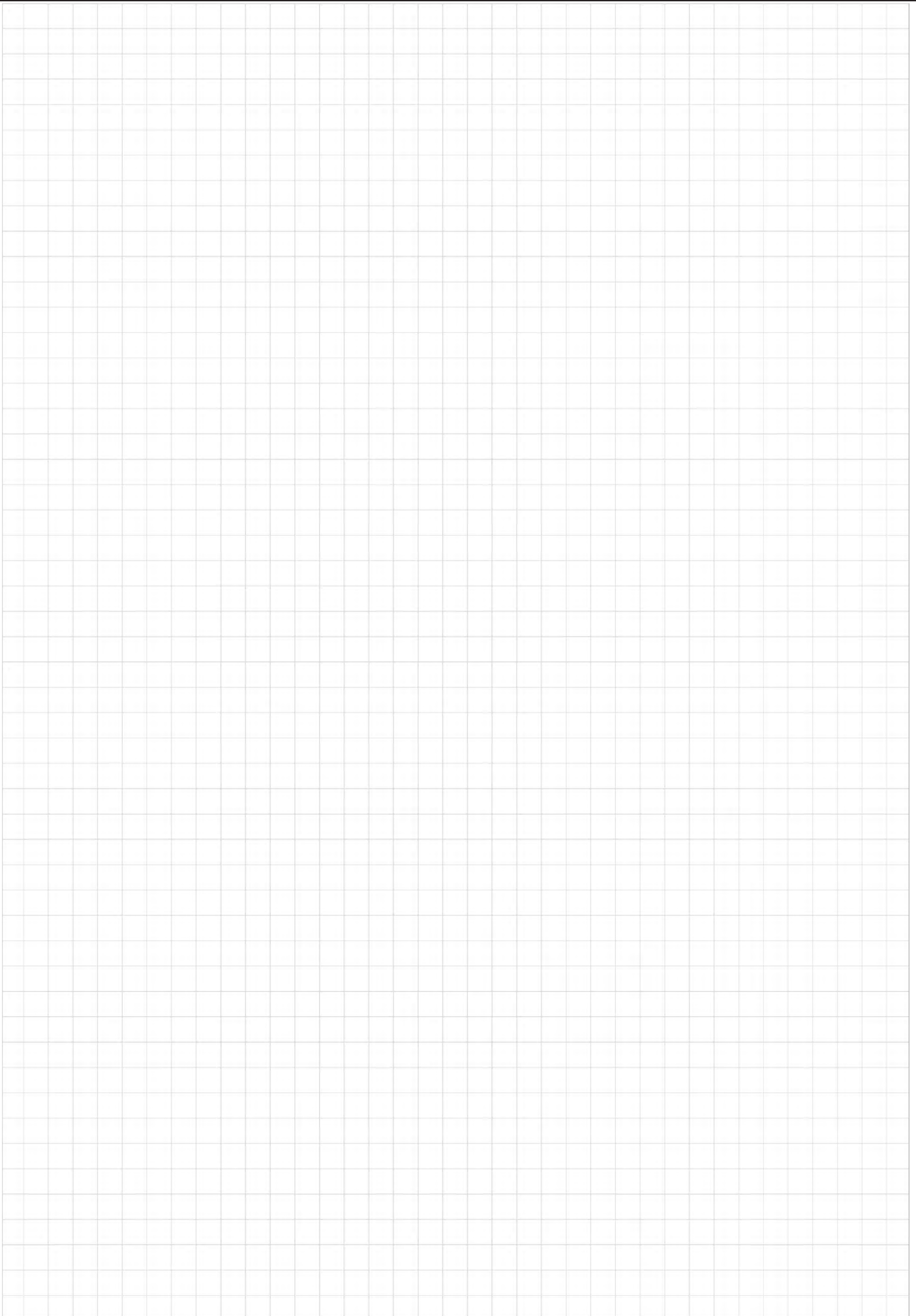

IP 66



- Controlling lighting installations
- High frequency motion sensor
- Adjustable on- off time
- The motion sensor, which features an 8 m beam width, a total switching load of 1200 W



CONSTRUCTION

Housing: aluminium powder painted casting
 Diffuser: borosilicate glass,
 Gasket: silicon

TECHNICAL DATA

Certificate:	FIDI 19 ATEX 0032
Marking:	CE 0722
Apparatus category:	II 2G II 2D
Marking of explosion protection:	Ex db eb IIC T6 Gb Ex tb IIIC T80°C Db
Ambient temperature:	-40°C ≤ T _{amb} ≤ +40°C
Degree of protection:	IP 66 category 1
Resistance to shock:	IK 08
Protection class :	I (protective earthing)
Rated voltage:	220-240 VAC
Frequency:	50Hz / 60Hz

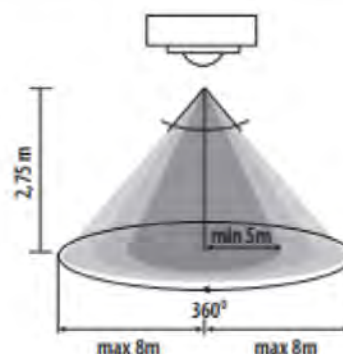
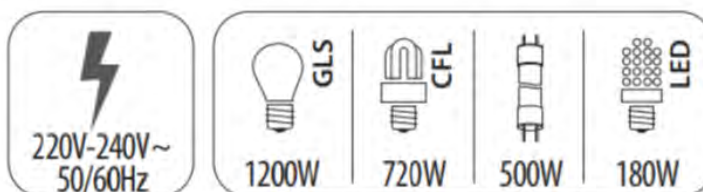
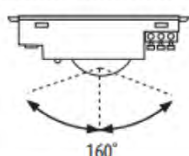
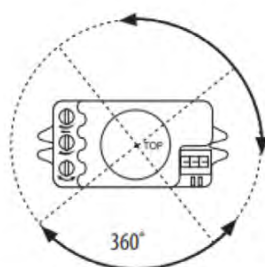

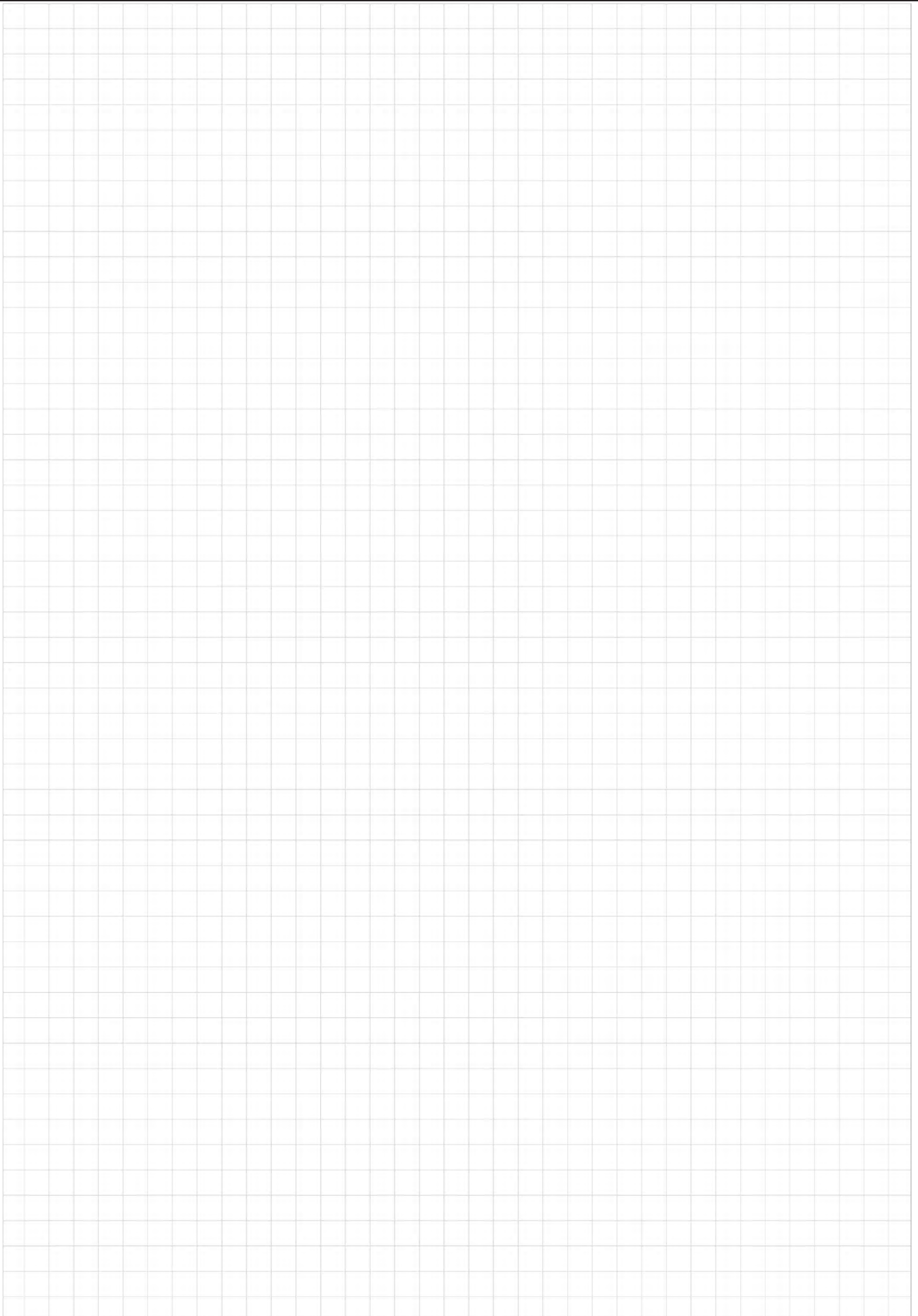



IP 66



mHPT



CONSTRUCTION

Glassfibre reinforced polyester

TECHNICAL DATA type mHPT

Certificate:	PBT 01 ATEX 1133
Marking:	CE ₀₁₀₂
Apparatus category:	II 2G
Marking of explosion protection:	Ex e mb IIC T5
Ambient temperature:	-20 °C ≤ T _a ≤ +70 °C
Degree of protection:	IP 54
Rated voltage:	24V DC, 115 V AC, 230 V AC
Terminals:	2,5mm ²
Cable entries:	1 x cable gland M20x1,5
Weight:	1,5 kg

DIMENSION

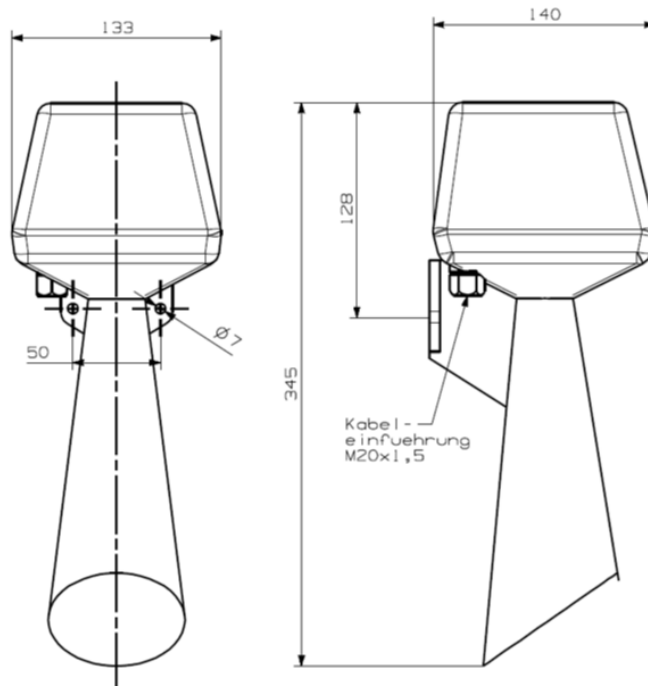

- Loud signal horn with typical horn tone
- Lower weight, robust and corrosion proof design
- Insulation class II, no equipotential bonding required

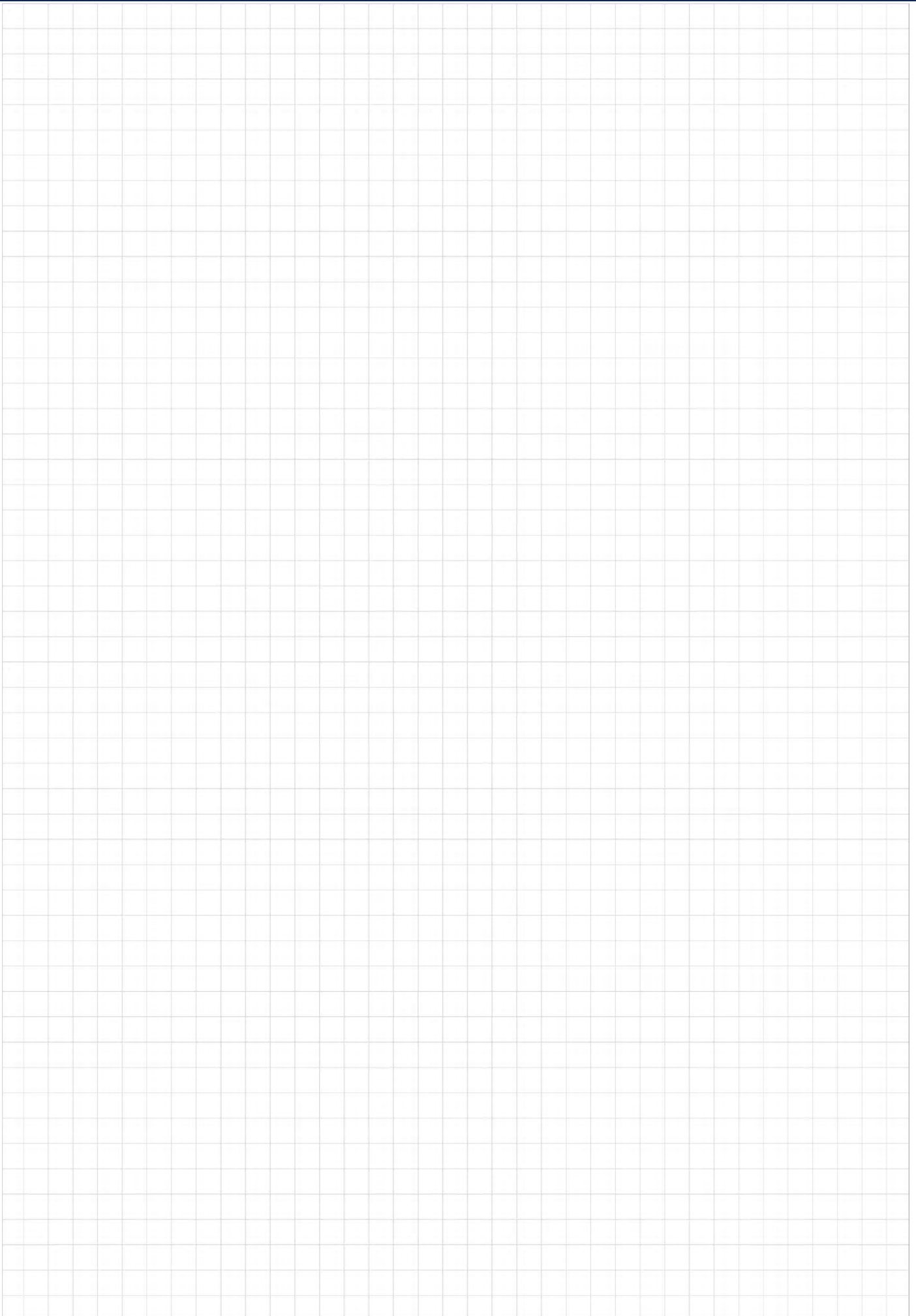



IP 66



- Loud signal bell with typical bell tone
- Insulation class II, no equipotential bonding required



CONSTRUCTION

Glassfibre reinforced polyester

TECHNICAL DATA type dHW

Certificate:	PBT 01 ATEX 1134
Marking:	CE ₀₁₀₂
Apparatus category:	II 2G II 2D
Marking of explosion protection:	Ex de IIC T6 Ex tD A21 IP66 T80 °C
Ambient temperature:	-20 °C ≤ T _a ≤ +40 °C
Degree of protection:	IP 66
Rated voltage:	6V AC/DC ÷ 220V AC/DC
Terminals:	2,5mm ²
Cable entries:	1 x cable gland M20x1,5 , 1 x plug M20 x1,5
Weight:	6 kg

DIMENSION

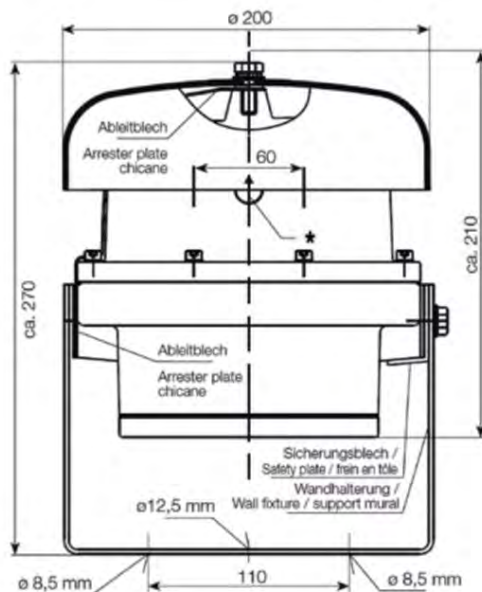

mounting bracket 4VA stainless

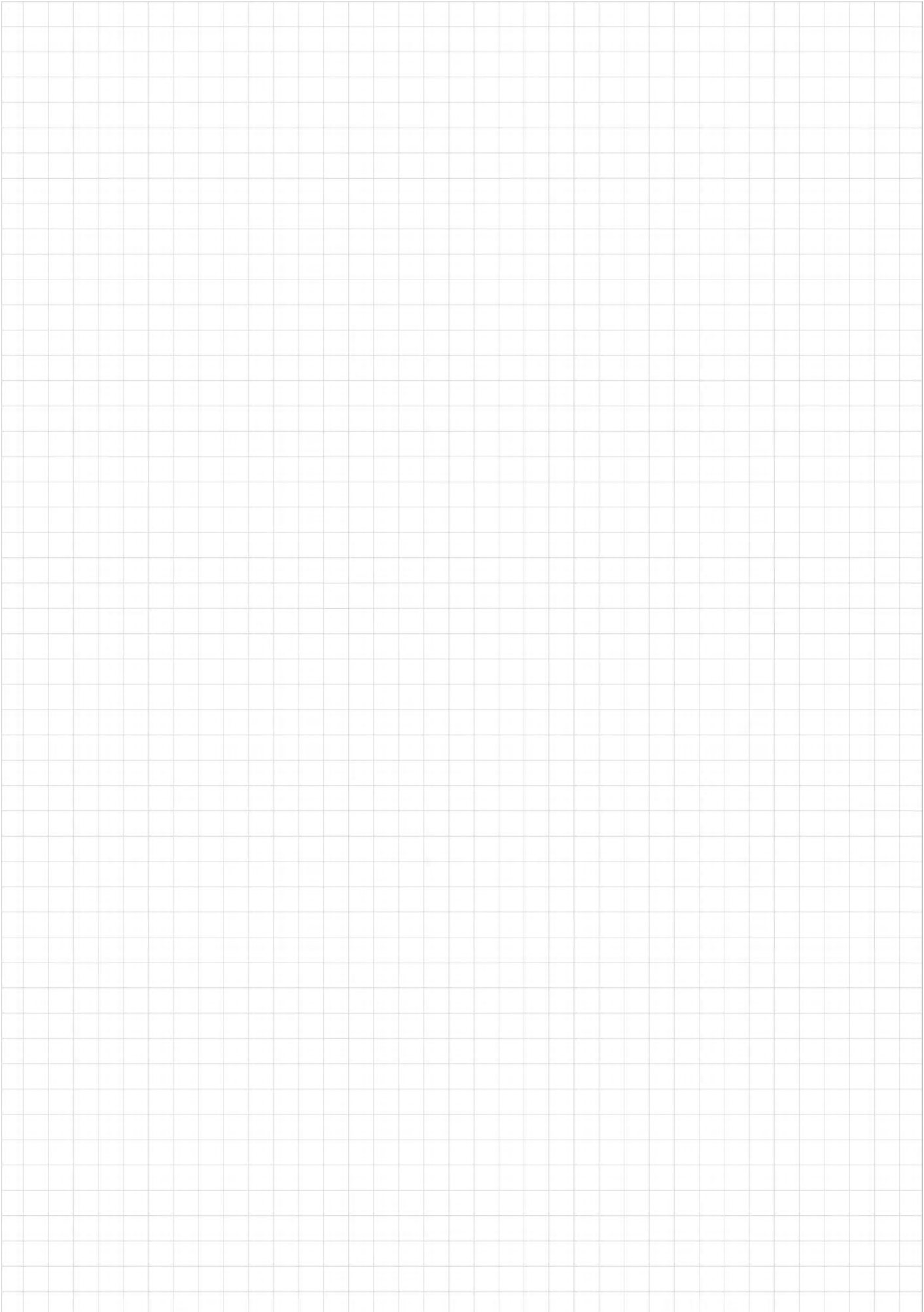

IP 66



IK 09



dST1



CONSTRUCTION

Glassfibre reinforced polyester

TECHNICAL DATA type dST1

Certificate:	DMT 03 ATEX E 034
Marking:	CE ⁰¹⁵⁸
Apparatus category:	II 2G II 2D
Marking of explosion protection:	Ex e mb [ib] IIC T5 Gb Ex tb [ib] IIIC T100°C Db
Ambient temperature:	-25 °C ≤ T _a ≤ +60°C
Degree of protection:	IP 66
Rated voltage:	24 V DC-66 V DC
Terminals:	4 mm ²
Cable entries:	1 x M20x1,5 2 x blind plug M20x1,5
Weight:	5,5 kg

DIMENSION

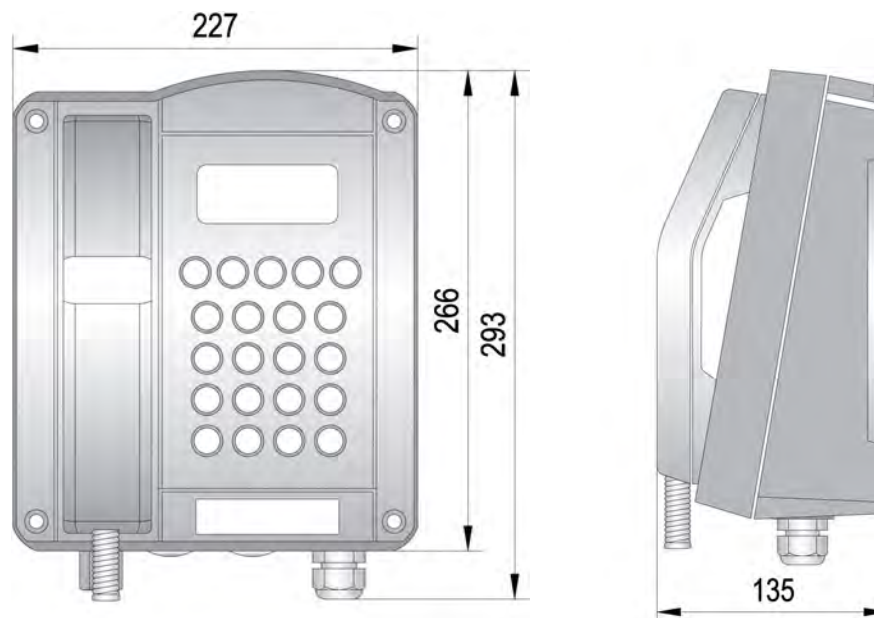

- Explosion-proof telephone for universal applications in the industry (onshore and offshore)
- Resistant against high temperature differences, humidity, seawater, acids, alkalis etc.
- 10 ringing tone melodies selectable
-

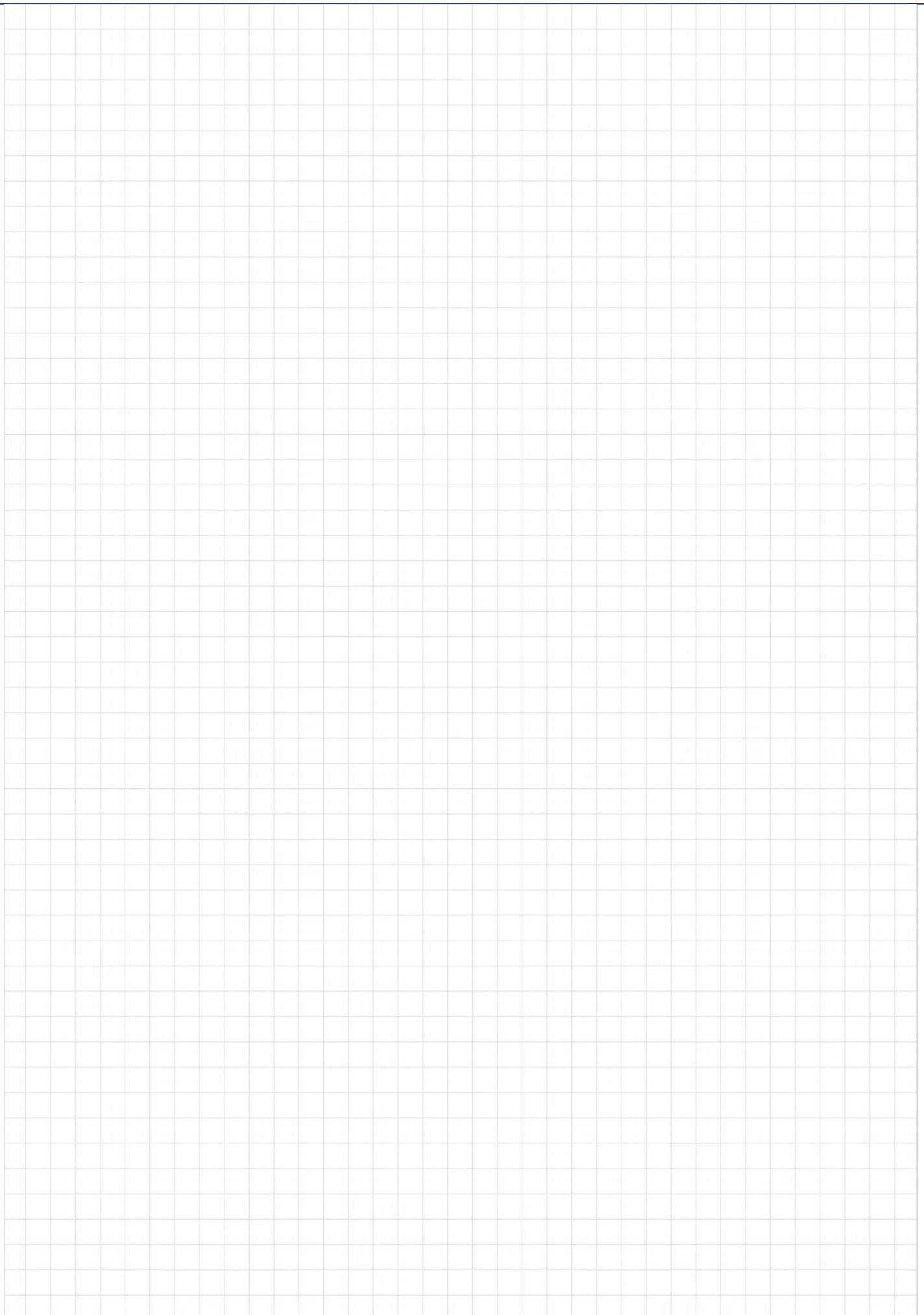

IP 66



IK 09



CONSTRUCTION

Socket/ 2P - 2P+E - 3P: polycarbonate
 Socket / 3P+E - 3P+N+E: SMC
 Plug, mobile socket, flush socket: polyamide

TECHNICAL DATA





Certificate:	LCIE 02 ATEX 6068, LCIE 02 ATEX 0001U
Marking:	CE 50228
Apparatus category:	II 2G II 2D
Marking of explosion protection:	Ex de IIC T6 Ex tD A21 T68°C
Ambient temperature:	-40 °C ≤ T _{amb} ≤ +55°C
Degree of protection:	IP 66
Impact resistance:	IK09

Plug	
Wall socket	
Mobile socket	
Flush socket	

- Plugs and sockets receptacles 16A to 63A, 12V to 690V
- All sockets incorporate switching technology that prevents removal of the plug under electrical load and does not disturb the potentially explosive atmospheres

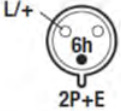

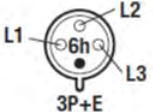

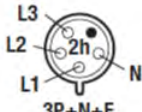
Plugs and sockets

MODEL CODE / 16A

Description	Pin Configuration	Weight kg (lb)	Volume dm ³ (in ³)	Catalog Number	
				IECEX	NBR
Low Voltage: LV					
100/130 Vac 50/60 Hz – Yellow					
Wall Socket		0.6 (1.3)	3.8 (231.89)	PRE316RY	NPRES316RY
Plug		0.2 (0.4)	0.6 (36.61)	PRE316PY	NPRES316PY
Mobile Socket		0.4 (0.9)	1.3 (79.33)	PRE316MY	NPRES316MY
Flush Socket		0.2 (0.4)	1.3 (79.33)	PRE316FY	NPRES316FY
200/250 Vac 50/60 Hz – Blue					
Wall Socket		0.6 (1.3)	3.8 (231.89)	PRE316RB	NPRES316RB
Plug		0.2 (0.4)	0.6 (36.61)	PRE316PB	NPRES316PB
Mobile Socket		0.4 (0.9)	1.3 (79.33)	PRE316MB	NPRES316MB
Flush Socket		0.2 (0.4)	1.3 (79.33)	PRE316FB	NPRES316FB
200/250 Vac 50/60 Hz – Blue					
Wall Socket		1.5 (3.3)	4.7 (286.81)	PRE416RB	NPRES416RB
Plug		0.6 (1.3)	0.6 (361.6)	PRE416PB	NPRES416PB
Mobile Socket		0.6 (1.3)	4.0 (244.09)	PRE416MB	NPRES416MB
Flush Socket		0.2 (0.4)	1.3 (79.33)	PRE416FB	NPRES416FB
Wall Socket		1.6 (3.5)	4.7 (286.81)	PRE516RB	NPRES516RB
Plug		0.3 (0.7)	1.3 (79.33)	PRE516PB	NPRES516PB
Mobile Socket		0.6 (1.3)	4.0 (244.09)	PRE516MB	NPRES516MB
Flush Socket		0.2 (0.4)	1.3 (79.33)	PRE516FB	NPRES516FB
		<i>(1) 120/208 V - 144/250 Vac 50/60 Hz</i>			
380/415 Vac 50/60 Hz – Red					
Wall Socket		1.5 (3.3)	4.7 (286.81)	PRE416RR	NPRES416RR
Plug		0.2 (0.4)	0.6 (361.6)	PRE416PR	NPRES416PR
Mobile Socket		0.6 (1.3)	4.0 (244.09)	PRE416MR	NPRES416MR
Flush Socket		0.3 (0.7)	1.3 (79.33)	PRE416FR	NPRES416FR
Wall Socket		1.6 (3.5)	4.7 (286.81)	PRE516RR	NPRES516RR
Plug		0.3 (0.7)	1.3 (79.33)	PRE516PR	NPRES516PR
Mobile Socket		0.6 (1.3)	4.0 (244.09)	PRE516MR	NPRES516MR
Flush Socket		0.3 (0.7)	1.3 (79.33)	PRE516FR	NPRES516FR
		<i>(2) 200/346 V - 240/415 Vac 50/60 Hz</i>			
480/500 Vac 50/60 Hz – Black					
Wall Socket		1.5 (3.3)	4.7 (286.81)	PRE416RN	NPRES416RN
Plug		0.2 (0.4)	0.6 (361.6)	PRE416PN	NPRES416PN
Mobile Socket		0.6 (1.3)	4.0 (244.09)	PRE416MN	NPRES416MN
Flush Socket		0.3 (0.7)	1.3 (79.33)	PRE416FN	NPRES416FN
50/500 Vac 300/500 Hz – Green					
Wall Socket		1.6 (3.5)	4.7 (286.81)	PRE516RG	NPRES516RG
Plug		0.2 (0.4)	0.6 (361.6)	PRE516PG	NPRES516PG
Mobile Socket		0.6 (1.3)	4.0 (244.09)	PRE516MG	NPRES516MG
Flush Socket		0.3 (0.7)	1.3 (79.33)	PRE516FG	NPRES516FG

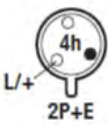

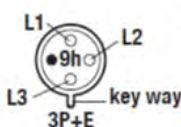
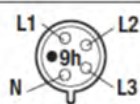
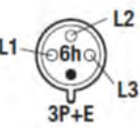
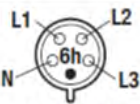



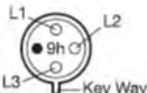
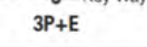

All technical data is relevant at the time of print.

MODEL CODE / 32A

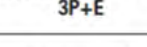
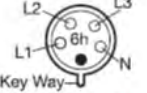
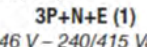
Description	Pin Configuration	Weight kg (lb)	Volume dm ³ (in ³)	Catalog Number	
				IECEx	NBR
100/130 Vac 50/60 Hz — Yellow					
Wall Socket		1.9 (4.19)	7.0 (427.17)	PRE332RY	NPRE332RY
Plug		0.5 (1.10)	4.0 (244.09)	PRE332PY	NPRE332PY
Mobile Socket		0.8 (1.76)	3.2 (195.28)	PRE332MY	NPRE332MY
Flush Socket		0.6 (1.32)	2.7 (164.76)	PRE332FY	NPRE332FY
200/250 Vac 50/60 Hz — Blue					
Wall Socket		1.9 (4.19)	7.0 (427.17)	PRE332RB	NPRE332RB
Plug		0.5 (1.10)	4.0 (244.09)	PRE332PB	NPRE332PB
Mobile Socket		0.8 (1.76)	3.2 (195.28)	PRE332MB	NPRE332MB
Flush Socket		0.6 (1.32)	2.7 (164.76)	PRE332FB	NPRE332FB
Wall Socket		1.9 (4.19)	7.0 (427.17)	PRE432RB	NPRE432RB
Plug		0.5 (1.10)	4.0 (244.09)	PRE432PB	NPRE432PB
Mobile Socket		0.8 (1.76)	3.2 (195.28)	PRE432MB	NPRE432MB
Flush Socket		0.6 (1.32)	2.7 (164.76)	PRE432FB	NPRE432FB
Wall Socket		1.9 (4.19)	7.0 (427.17)	PRE532RB	NPRE532RB
Plug		0.5 (1.10)	4.0 (244.09)	PRE532PB	NPRE532PB
Mobile Socket		1.0 (2.20)	4.0 (244.09)	PRE532MB	NPRE532MB
Flush Socket		0.6 (1.32)	2.7 (164.76)	PRE532FB	NPRE532FB
380/415 Vac 50/60 Hz — Red					
Wall Socket		2.0 (4.41)	7.0 (427.17)	PRE432RR	NPRE432RR
Plug		0.4 (0.88)	4.0 (244.09)	PRE432PR	NPRE432PR
Mobile Socket		0.8 (1.76)	3.2 (195.28)	PRE432MR	NPRE432MR
Flush Socket		0.6 (1.32)	2.7 (164.76)	PRE432FR	NPRE432FR
Wall Socket		2.0 (4.41)	7.0 (427.17)	PRE532RR	NPRE532RR
Plug		0.5 (1.10)	4.0 (244.09)	PRE532PR	NPRE532PR
Mobile Socket		1.0 (2.20)	4.0 (244.09)	PRE532MR	NPRE532MR
Flush Socket		0.6 (1.32)	2.7 (164.76)	PRE532FR	NPRE532FR
480/500 Vac 50/60 Hz — Black					
Wall Socket		2.0 (4.41)	7.0 (427.17)	PRE432RN	NPRE432RN
Plug		0.4 (0.88)	4.0 (244.09)	PRE432PN	NPRE432PN
Mobile Socket		1.0 (2.20)	4.0 (244.09)	PRE432MN	NPRE432MN
Flush Socket		0.6 (1.32)	2.7 (164.76)	PRE432FN	NPRE432FN

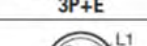
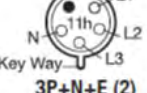
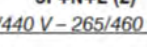
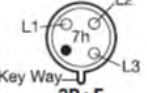
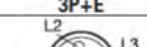
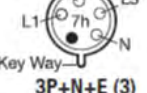
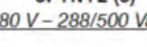
Plugs and sockets

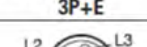
MODEL CODE / 63A

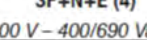
Description	Pin Configuration	Weight kg (lb)	Volume dm ³ (in ³)	Catalog Number	
				IECEX	NBR
200/250 Vac 50/60 Hz – Blue					
Wall Socket		8.0 (17.64)	26.0 (1586.62)	PRE463RBU5	NPRE463RBU5
Plug		1.0 (2.20)	7.0 (427.17)	PRE463PB	NPRE463PB
380/415 Vac 50/60 Hz – Red					
Wall Socket		8.0 (17.64)	26.0 (1586.62)	PRE463RRU5	NPRE463RRU5
Plug		1.0 (2.20)	7.0 (427.17)	PRE463PR	NPRE463PR
Wall Socket		8.0 (17.64)	26.0 (1586.62)	PRE563RRU5	NPRE563RRU5
Plug		1.0 (2.20)	7.0 (427.17)	PRE563PR	NPRE563PR
<i>(1) 200/346 V – 240/415 Vac 50/60 Hz</i>					
440/460 Vac 60 Hz – Red					
Wall Socket		8.0 (17.64)	26.0 (1586.62)	PRE463RR1U5	NPRE463RR1U5
Plug		1.0 (2.20)	7.0 (427.17)	PRE463PR1	NPRE463PR1
Wall Socket		8.0 (17.64)	26.0 (1586.62)	PRE563RR1U5	NPRE563RR1U5
Plug		1.0 (2.20)	7.0 (427.17)	PRE563PR1	NPRE563PR1
<i>(2) 250/440 V – 265/460 Vac 60 Hz</i>					
480/500 Vac 50/60 Hz – Black					
Wall Socket		8.0 (17.64)	26.0 (1586.62)	PRE463RNU5	NPRE463RNU5
Plug		1.0 (2.20)	7.0 (427.17)	PRE463PN	NPRE463PN
Wall Socket		8.0 (17.64)	26.0 (1586.62)	PRE563RNU5	NPRE563RNU5
Plug		1.0 (2.20)	7.0 (427.17)	PRE563PN	NPRE563PN
<i>(3) 277/480 V – 288/500 Vac 50/60 Hz</i>					
600/690 Vac 50/60 Hz – Black					
Wall Socket		8.0 (17.64)	26.0 (1586.62)	PRE463RN1U5	NPRE463RN1U5
Plug		1.0 (2.20)	7.0 (427.17)	PRE463PN1	NPRE463PN1
Wall Socket		8.0 (17.64)	26.0 (1586.62)	PRE563RN1U5	NPRE563RN1U5
Plug		1.0 (2.20)	7.0 (427.17)	PRE563PN1	NPRE563PN1
<i>(4) 347/600 V – 400/690 Vac 50/60 Hz</i>					

DIMENSION / 16A

16A – 2P – 2P+E – 3P Versions

Wall Mounting Sockets

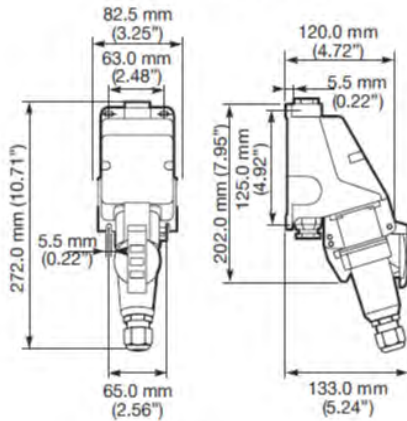

Plugs

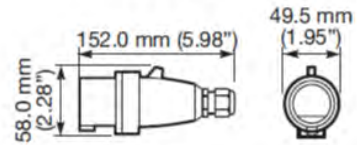

Mobile Sockets

Can be mounted on panel - 0.12"/3.0 mm thickness maximum

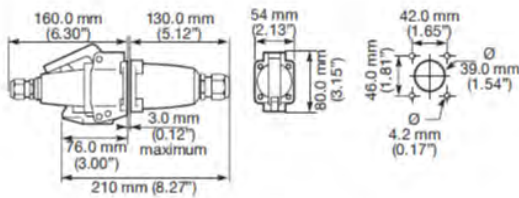

Flush Sockets

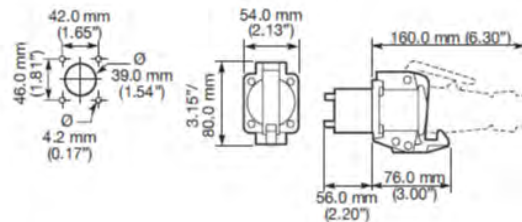

16A – 3P+E – 3P+N+E Versions

Wall Mounting Sockets

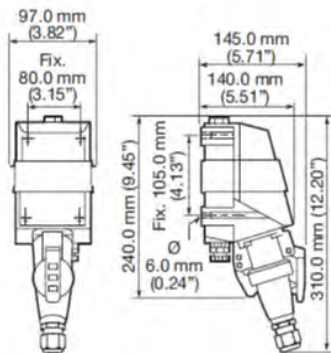

Plugs

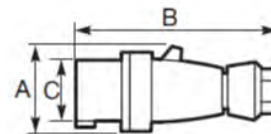

Dimensions in Millimeters (Inches)			
	A	B	C
3 P + E	66.0 (2.60)	154.0 (6.06)	55.5 (2.19)
3 P + N + E	73.0 (2.87)	166.0 (6.54)	62.0 (2.44)

Mobile Sockets

Can be mounted on panel - 3.0 mm (0.12") thickness maximum

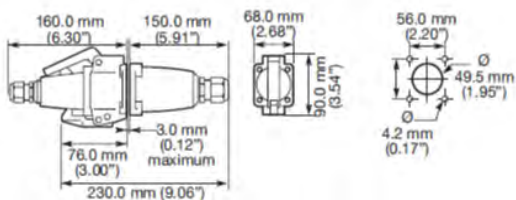

Flush Sockets

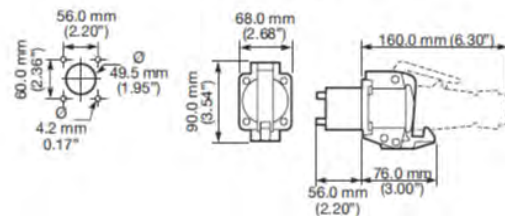

DIMENSION / 32A

32A — 2P+E — 3P+E — 3P+N+E Versions

Wall Mounting Sockets

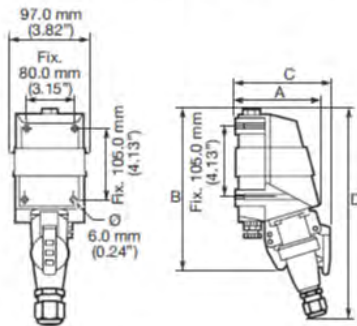

Plugs

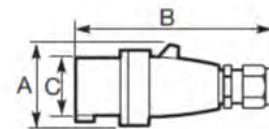

Dimensions in Millimeters (Inches)				
	A	B	C	D
2 P + E	140.0 (5.51)	275.0 (10.83)	155.0 (6.10)	370.0 (14.67)
3 P + E	140.0 (5.51)	275.0 (10.83)	155.0 (6.10)	370.0 (14.67)
3 P + N + E	140.0 (5.51)	275.0 (10.83)	165.0 (6.50)	375.0 (14.76)

Dimensions in Millimeters (Inches)			
	A	B	C
2 P + T	80.0 (3.15)	170.0 (6.69)	67.0 (2.64)
3 P + T	80.0 (3.15)	170.0 (6.69)	67.0 (2.64)
3 P + N + T	80.0 (3.15)	195.0 (7.68)	74.0 (2.91)

Mobile Sockets

Can be mounted on panel - 3.0 mm (0.12") thickness maximum

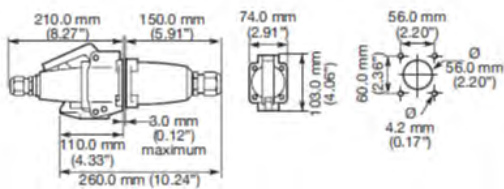

Flush Sockets

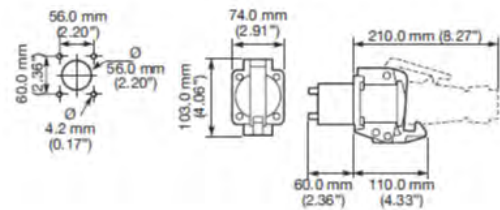

DIMENSION / 63A

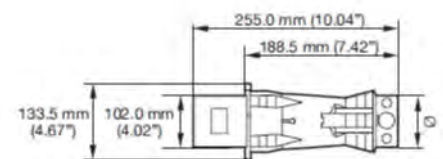
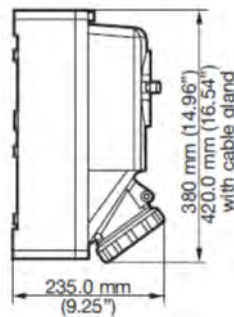
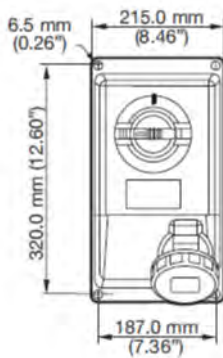

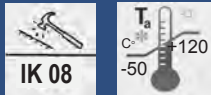

CONSTRUCTION

Brass body (SS AISI 316 on special request)

TECHNICAL DATA

Certificate:	Ex FIDI 19 ATEX 0013U , IECEx EXA 16.0003U
Marking:	CE 0722
Apparatus category:	II 2G I M2
Marking of explosion protection:	Ex db IIC Gb Ex db I Mb
Service temperature:	-50°C ≤ T _{service} ≤ +120°C
Rated voltage U_o / U :	400/1000 V AC
Rated current I_e:	Determined by technical data of device
Wire:	- rated cross-section 1,5 - 50 mm ² - type RADOX 155 or BETAtherm 155 IEC 60228 class 5

MODEL CODE

TYPE	NUMBER AND CROSS-SECTION OF WIRES	SIZE OF THREAD/ THREAD LENGTH (mm)	KEY SIZE AF/ BUSHING LENGTH (mm)	WIRE LENGTH (THREAD SIDE) (mm)	TOTAL WIRE LENGTH (mm)
RSM 21	4 x 1,5mm ²	M25x1,5-6g/18	OK 30 / 30	150	330
RSM 23	6 x 1,5mm ²				
RSM 25	8 x 1,5mm ²				
RSM 30	10 x 1,5mm ²	M33x1,5-6g/18	OK 36 / 30	150	3x440 + 3x310
RSM 31	12 x 1,5mm ²				
RSM 33	6 x 2,5 mm ²				
RSM 35	6 x 4 mm ²	M36x1,5-6g/18	OK 41 / 30	110	3x440 + 3x310
RSM 37	6 x 6 mm ²				
RSM 41	6 x 10 mm ²				
RSM 51	6 x 16mm ²	M42x1,5-6g/18	OK 46 / 30	150	480
RSM 53	3 x 25mm ²				
RSM 55	3 x 35mm ²				
RSM 61	6 x 25mm ²	M50x1,5-6g/18	OK 55 / 30	150	480
RSM 63	6 x 35mm ²				
RSM 65	3 x 50mm ²				
RSM 91	12 x 1,5mm ²	2 x M32x1,5-6g/18	OK 41 / 54	500	1030

Other configurations available on request

- For electrical connection between flameproof enclosures or between flameproof enclosure and enclosure with another type of protection

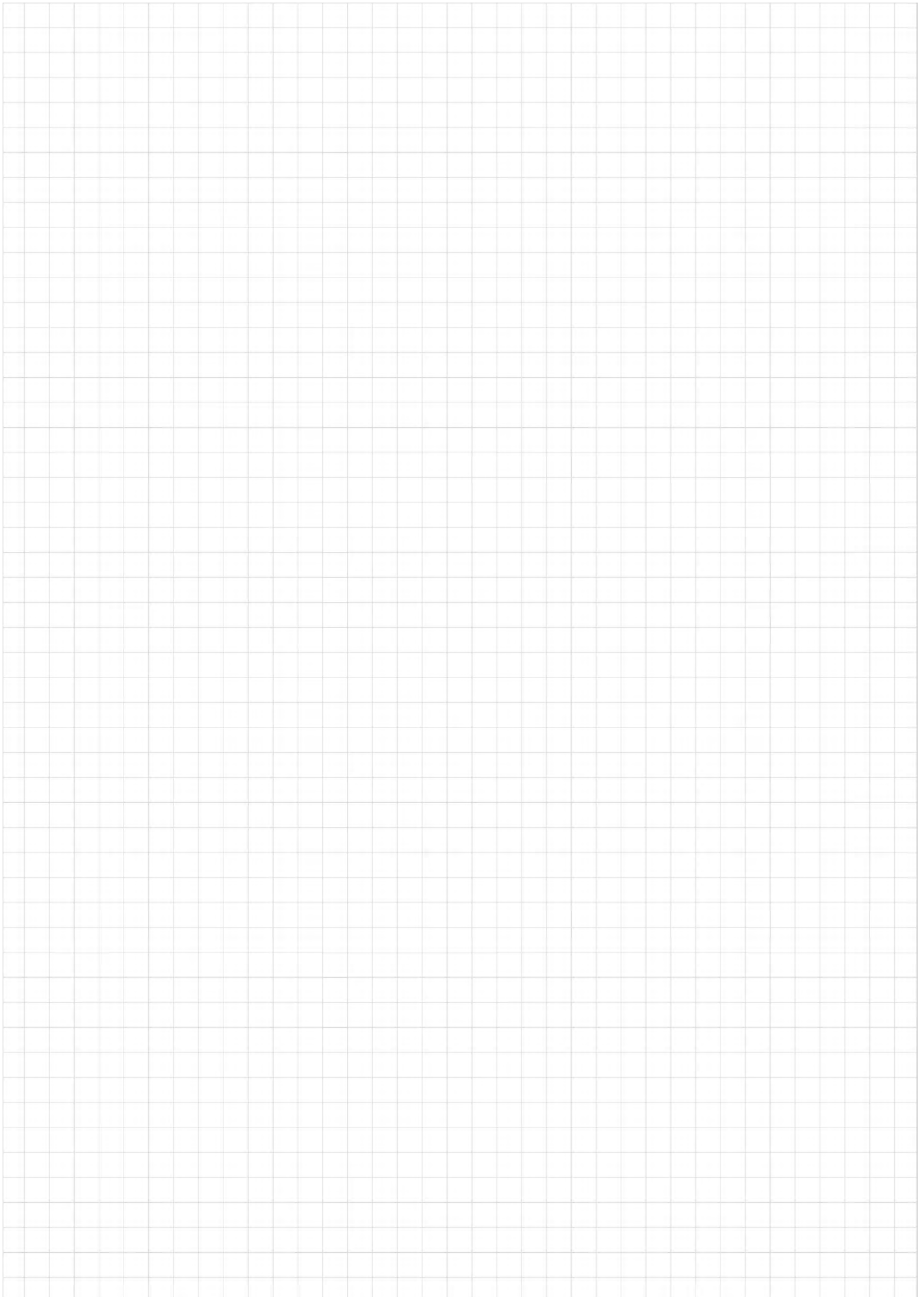

Cable glands

IP 68



PLASTIC CABLE GLANDS Exe

Polyamide body / neoprene gasket

TECHNICAL DATA

Apparatus category:	II 2GD
Marking of explosion protection:	Ex e, Ex i
Ambient temperature:	$-35\text{ °C} \leq T_{\text{amb}} \leq +95\text{ °C}$
Degree of protection:	IP 68

MODEL CODE

THREADS	CLAMPING RANGE	H (mm)	E (mm)	L (mm)	RAL 5012	RAL 9005
M12	4,0 - 6,5	15	15	39	F7431200E	F8031200E
M16	5,0 - 10,0	22	15	44	F7431600E	F8031600E
M20	7,0 - 12,0	24	15	45	F7432050E	F8032050E
M25	12,0 - 18,0	33	15	53	F7432500E	F8032500E
M25	7,00 - 15,0	33	15	53	SPU 25 B	SPU 25
M32	16,0 - 25,0	42	15	57	F7433200E	F8033200E
M40	22,0 - 32,0	53	16	68	F7434000E	F8034000E
M50	28,0 - 38,5	50	16	71	F7435000E	F8035000E
M63	40,0 - 48,0	70	16	72	F7436300E	F8036300E

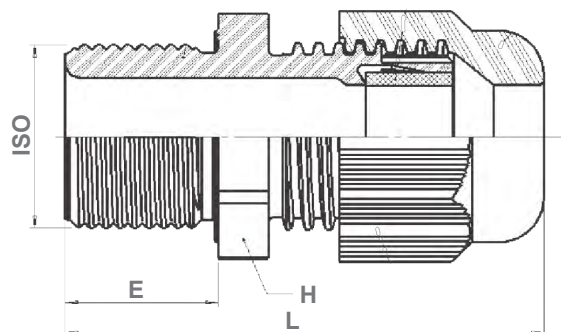

- Ex e plastic cable glands
- Ex d metal cable glands for armored cable

Plugs, adapters, reducers, locknuts



METAL Ex d/e CABLE GLANDS (double sealing, for armoured cable) type 4F

Brass nickel plated (AISI 316 on special request)

TECHNICAL DATA

Apparatus category:	II 2GD
Marking of explosion protection:	 Ex d/e
Ambient temperature:	$-40\text{ °C} \leq T_{\text{amb}} \leq +95\text{ °C}$
Degree of protection:	IP 68

MODEL CODE

THREADS	CLAMPING RANGE	H (mm)	E (mm)	CODE
M16	7,0 - 12,0	20	16	4114169
M20	9,0 - 16,0	24	16	4114219
M20	13,0 - 21,0	28	16	4114229
M25	13,0 - 21,0	30	16	4114269
M25	17,0 - 27,5	36	16	4114279
M32	22,0 - 34,0	44	16	4114339
M40	28,0 - 41,0	50	16	4114419
M50	34,0 - 48,0	64	16	4114519
M63	39,0 - 54,0	70	16	4114639
M63	48,0 - 65,0	80	16	4114649
M75	55,0 - 74,0	90	18	4114769

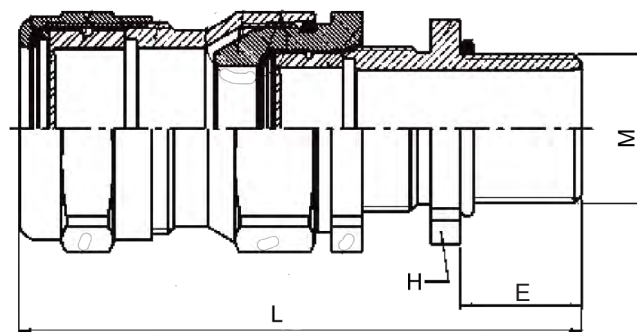

OTHER ACCESSORIES



Other accessories (Exd metal plugs, Exe plastic plugs, adapters, reducers, locknuts, earth tags) are available according to customer request.

All technical data is relevant at the time of print.

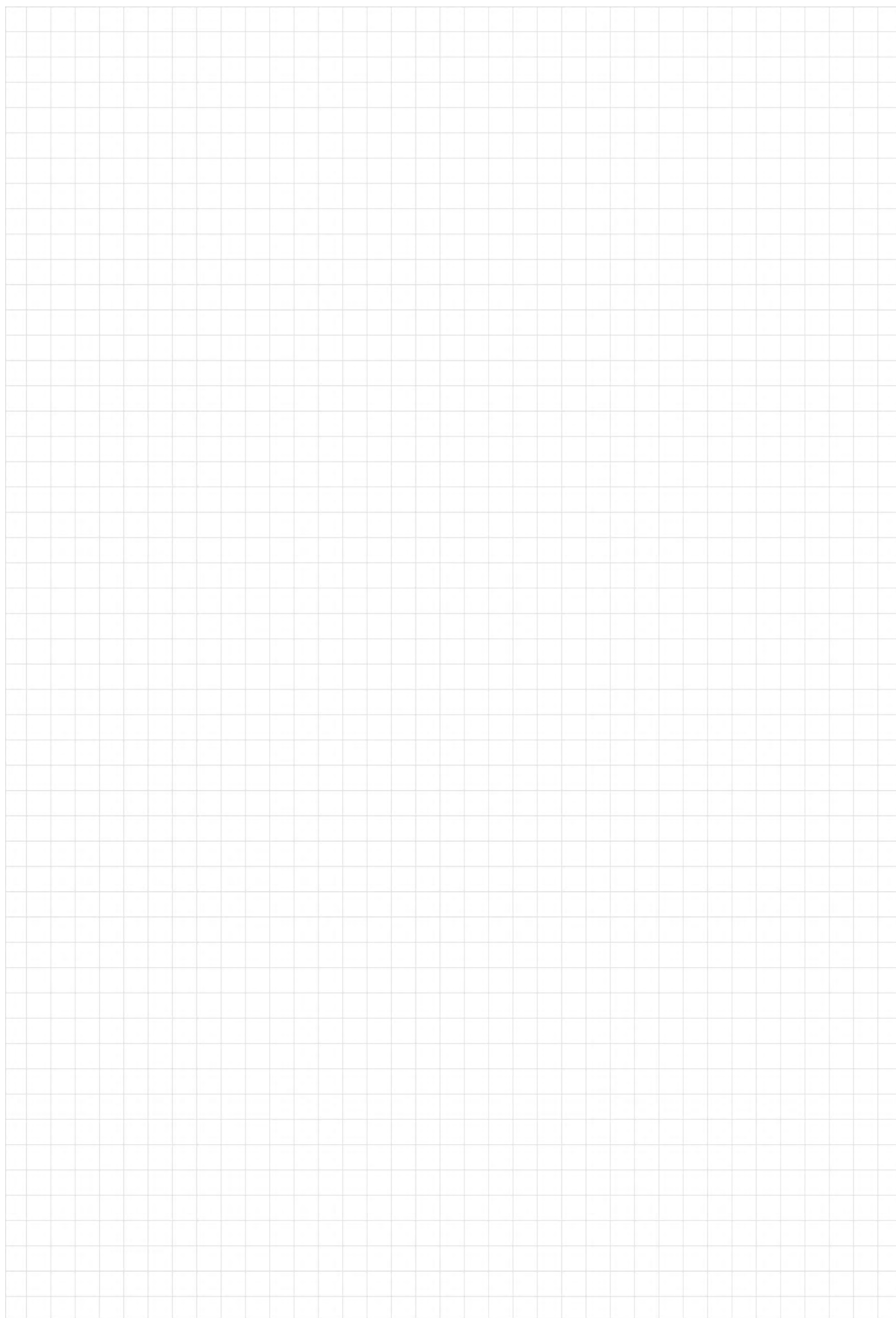

AVAILABILITY, DESIGN AND SPECIFICATIONS ARE SUBJECT TO CHANGE WITHOUT NOTICE.
ALL RIGHTS RESERVED.
PRINTED IN THE REPUBLIC OF CROATIA, JANUARY 2020, TEPEX D.O.O.

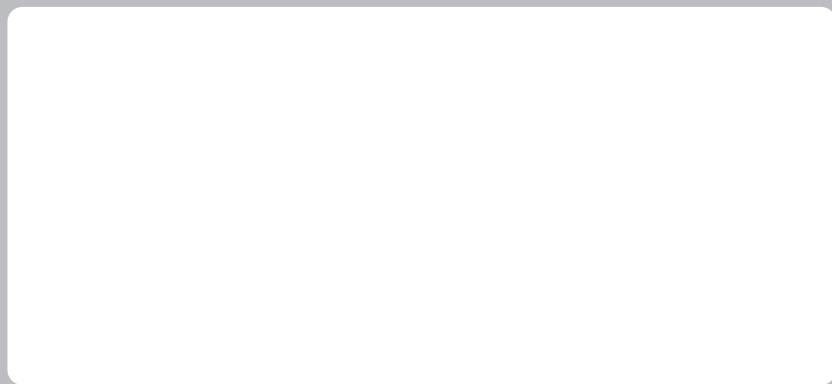

TEP Ex

Prilaz dr.F.Tuđmana 6, 49210 ZABOK, CROATIA

Tel: +385 49 222 900, +385 49 426 451

Fax: +385 49 426 450

@: tepex@tepex.hr prodaja@tepex.hr

Web: www.tepex.hr